

UNIVERSIDAD AUTONOMA DE NUEVO LEON
FACULTAD DE INGENIERIA MECANICA
Y ELECTRICA



MEMORIA PARA EXAMEN PROFESIONAL
DE LA CARRERA DE INGENIERO MECANICO
ADMINISTRADOR

PRESENTA

ALFREDO ANTONIO DE LA ROSA HERNANDEZ

CURSO

PRUEBAS MECANICAS EN LOS MATERIALES
POR COMPUTADORA

EXPOSITOR: M.C. DANIEL RAMIREZ VILLARREAL

CD. UNIVERSITARIA

MAYO DE 1996

T

TA410

R355

C.1



1080086894

UNIVERSIDAD AUTONOMA DE NUEVO LEON
FACULTAD DE INGENIERIA MECANICA
Y ELECTRICA



MEMORIA PARA EXAMEN PROFESIONAL
DE LA CARRERA DE INGENIERO MECANICO
ADMINISTRADOR

PRESENTA

ALFREDO ANTONIO DE LA ROSA HERNANDEZ

CURSO

PRUEBAS MECANICAS EN LOS MATERIALES
POR COMPUTADORA

EXPOSITOR: M.C. DANIEL RAMIREZ VILLARREAL



X
X 410
R3 S



**UNIVERSIDAD AUTONOMA DE NUEVO LEON
FACULTAD DE INGENIERIA MECANICA Y ELECTRICA**



**MEMORIA PARA EXAMEN PROFESIONAL
DE LA CARRERA DE INGENIERO MECANICO ADMINISTRADOR**

PRESENTA

ALFREDO ANTONIO DE LA ROSA HERNANDEZ

CURSO

PRUEBAS MECANICAS EN LOS MATERIALES POR COMPUTADORA

EXPOSITOR : M . C . DANIEL RAMIREZ VILLARREAL

CURSO -TESIS
PRUEBAS MECÁNICAS EN LOS MATERIALES.

ÍNDICE	PÁGINA
1.- Clasificación de los materiales.	2
2.- Estructura de los materiales:	3
⇒ Metales	
⇒ Polímeros	
3.- Propiedades y características mecánicas básicas.	11
4.- Máquinas, accesorios, aditamentos e instrumentos de medición.	23
Bibliografía	

1.- Clasificación de los Materiales

1.- Ferrosos:

Aceros: Ordinarios
Aleados

Fundiciones: Grises: Nodular
Ferrítico
Perlítico
Blancas: H. Martensíticos
Especiales Aleaciones

2.- No-Ferrosos: Cobre y sus Aleaciones
Aluminio y sus Aleaciones
Níquel, Cromo, Estaño, etc.

3.- Orgánicos: Madera
Polímeros
Elastómeros

4.- Inorgánicos: Fibras Compuestas
Cerámicos
Vidrios
Minerales

DIAGRAMA DE OBTENCIÓN DEL HIERRO Y EL ACERO

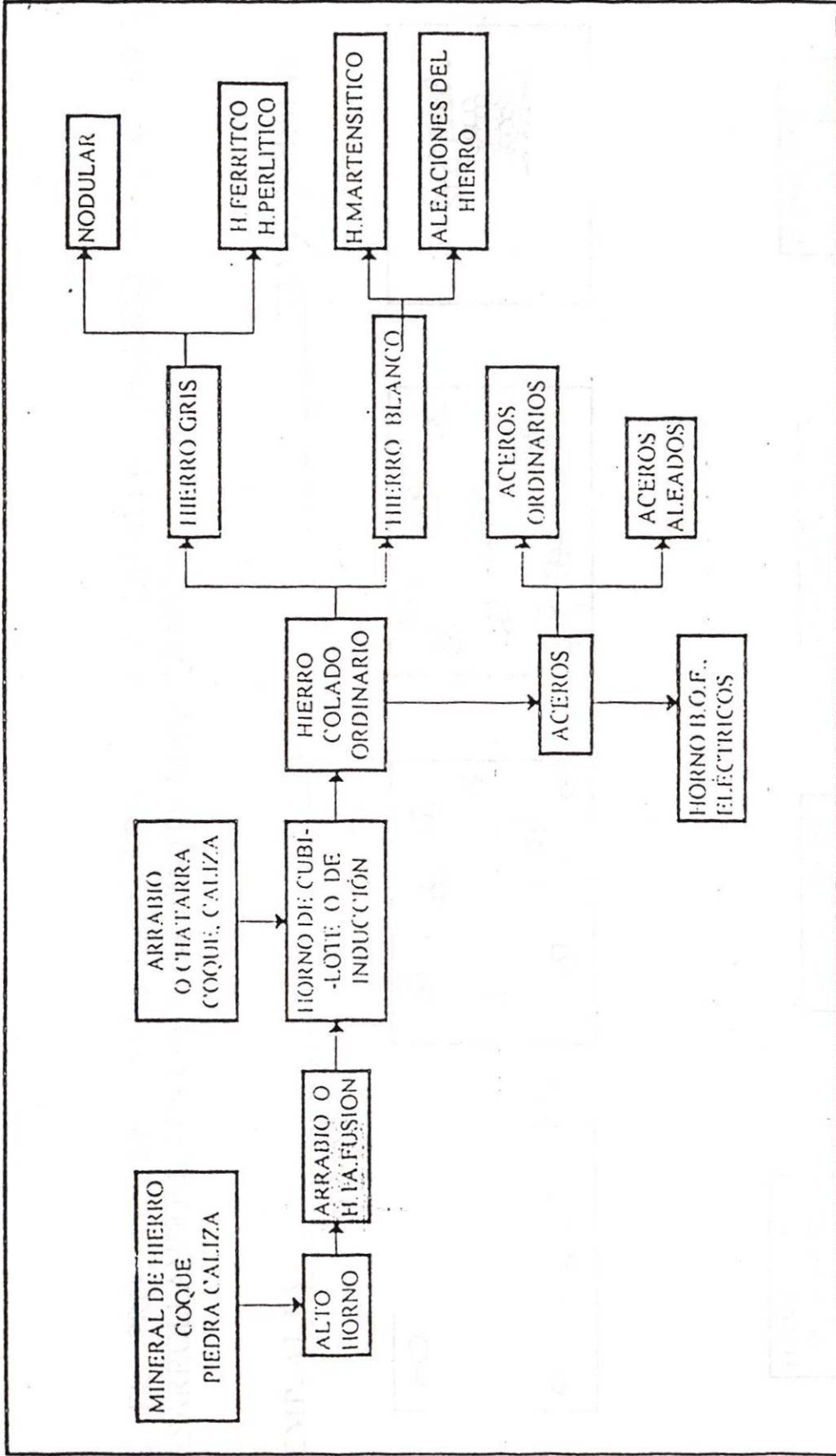

MECANISMOS DE CRISTALIZACIÓN EN LOS METALES

ES EL PROCESO DE TRANSFORMACIÓN DE UN ESTADO LÍQUIDO A UNO SÓLIDO DESARROLLÁNDOSE LOS CRISTALES EN FORMA ORDENADA.

TEMP. ALTA

TEMP. NORMAL

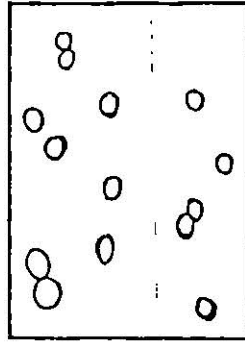

FORMACIÓN DE NÚCLEOS DE ÁTOMOS

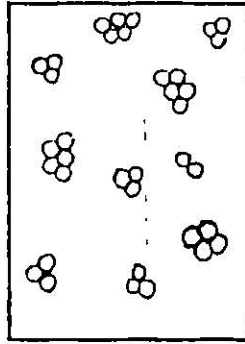

FORMACIÓN DE DENDRITAS

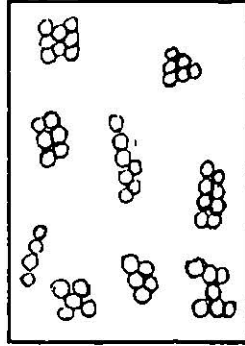

CRECIMIENTO DE CRISTALES

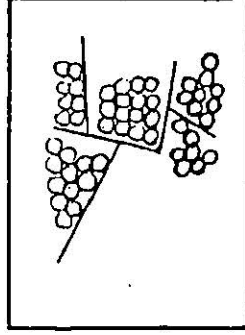

FORMACIÓN DE LÍMITES DE GRANO

2.- Estructura de los Materiales

METALES

PARA METALES: su estructura está compuesta por agrupamiento de átomos.

Estados de la Materia en la Obtención de un Metal

- * Gaseosos
- * Líquidos
- * Sólidos

Tipos de Enlaces

- * Iónico
- * Metálico
- * Covalente
- * Vander-Walls
- * Puente de Hidrógeno

Red o estructura cristalina: agrupación de átomos en forma ordenada denominadas celdillas espaciales.

Características de la red:

- * Sus longitudes
- * Sus ángulos

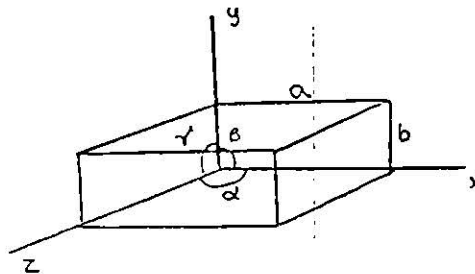

LOS SIETE SISTEMAS CRISTALINOS

1.- Monoclínico

- a) Simple
- b) De extremos centrados

2.- Triclínico

- a) Simple

3.- Hexagonal

- a) Con extremos centrados

4.- Romboédrico

- a) Simple

5.- Ortorrómbico

- a) Simple
- b) Cuerpo centrado
- c) Extremos centrados
- d) Caras centradas

6.- Tetragonal

- a) Simple
- b) Cuerpo centrado

7.- Cúbico

- a) Simple
- b) Cuerpos centrados
- c) Caras centradas

Los sistemas de cristalización más comunes son:

- ⇒ Cúbico*
- ⇒ Hexagonal*
- ⇒ Tetragonal
- ⇒ Ortorrómbico
- ⇒ Romboédrico

Defectos o imperfecciones del cristal:

- ⇒ Vacancias
- ⇒ Intersticios
- ⇒ Dislocaciones (Borde y Helicoidales)

Polimorfismo o Alotropía: es cuando el material se presenta en varias formas

* En metales

NOVIEMBRE DE 1995

REDES ESPACIALES O TIPOS DE ESTRUCTURAS CRISTALINAS

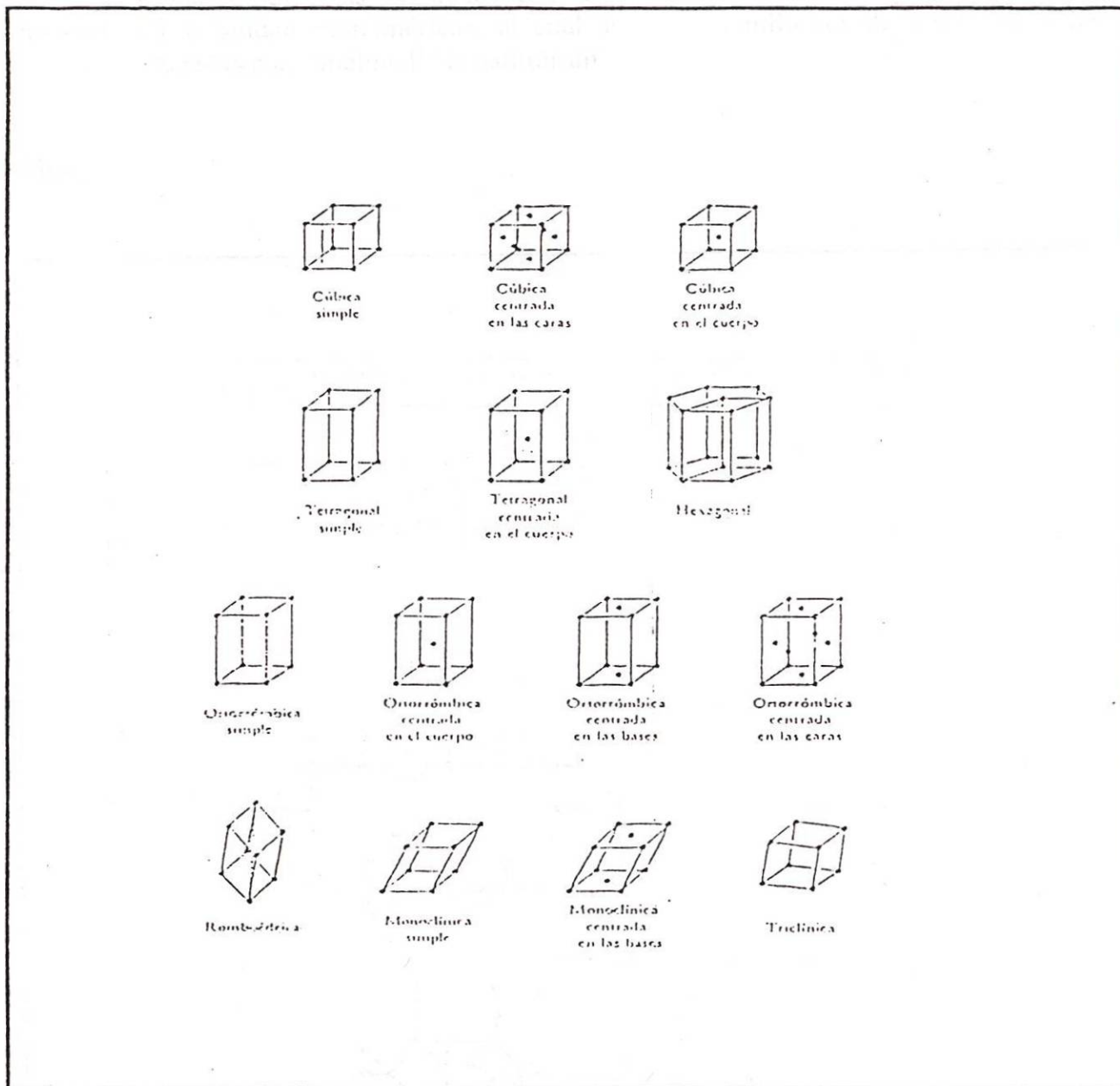

Los siete sistemas de estructura cristalina y las 14 redes de Bravais.

ESTRUCTURA DE LOS POLÍMEROS

Son macromoléculas orgánicas que a través de un enlace químico forman el monómero (o unidad monomérica), el cual se repetirá millones de veces en cadenas lineales o cruzadas para finalmente constituir un polímero.

Ejemplo:

UNIDADES REPEITIVAS Y PROPIEDADES PARA LOS MATERIALES POLIQUÍMICOS QUE FORMAN LAS CADENAS DE ESCENOS COMPLEJOS:

Polímero	Estructura	Repetición a lo largo de (g/mol)	Densidad (g/cm ³)	Temperatura de fusión (°C)	Temperatura de ruptura (°C)
Polietileno (lineal)		5,500-10,000	73-75	35	142
Polipropileno (lineal)		5,500-10,000	85-90	45-55	150
Policarbonato		5,000-11,000	110-115	220-292	17
Celulosa		1,500-2,000	5-30	250-310	120

POLÍMEROS

CARACTERÍSTICAS GENERALES DE LOS POLÍMEROS:

- * Ligeros
- * Resistentes a la Corrosión
- * Aislantes Eléctricos
- * Baja Resistencia a la Tensión
- * No usados en Temperaturas Altas
- * Muy usual

CLASIFICACIÓN DE LOS POLÍMEROS:

Según su Mecanismo de Polimerización:

Polímeros por adición: son cadenas formadas por el enlace covalente de las moléculas.

Polímeros por condensación: se producen cuando se unen dos o más tipos de moléculas mediante una reacción química que libera agua.

Según su Estructura:

Polímeros lineales: son cadenas largas de moléculas, que son formadas por una reacción de adición o condensación.

Polímeros de red: son estructuras **reticulares** tridimensional producidos mediante un proceso de enlaces cruzados que implica una reacción de adición condensación.

Según su Comportamiento:

Polímeros termoplásticos: son polímeros de estructura **lineal**, que se comportan de manera plástica a elevadas temperaturas y pueden ser conformados a temperaturas elevadas, enfriados y luego recalentados y conformados.

Polímeros termoestables o termofijos: son de red o estructura tridimensional **reticulado** por lo que se consideran rígidos y no se ablandan cuando se calientan se forman por reacción de condensación no se pueden reprocesar debido a que parte de las moléculas salen del material.

Según su Grado de Polimerización:

- * Homopolímeros (un sólo material)
- * Copolímeros (dos o más tipos)
- * Oligopolímeros (pocos monómeros)
- * Polímeros

Según su Naturaleza:

- * Naturales (lino, seda, asbesto, celulosa)
- * Artificiales o sintéticos (rayón, nitrato de celulosa)
- * Según su origen
- * Vegetales (algodón, celulosa, etc.)
- * Animales (pelos)
- * Minerales (asbestos, fibra de vidrio)

POLÍMEROS INORGÁNICOS:

Son macromoléculas que se constituyen de cadenas que no contienen átomos de carbono.

Clasificación:

Naturales: Asbestos
Fibras de carbono o de grafito obtenidas por extrusión.

Artificiales: Fibra de vidrio
Silicones

ELASTOMEROS

Elastómero (caucho o hules): es una cadena polimérica que se encuentra enrollada debido al arreglo cis de los enlaces, por lo que al aplicarse una fuerza se alarga al desenrollarse las cadenas lineales, deslizándose unas sobre otras y provocando una combinación de deformación plástica y elástica. Tienen un comportamiento intermedio y la capacidad de deformarse elásticamente en alto grado sin cambiar de forma.

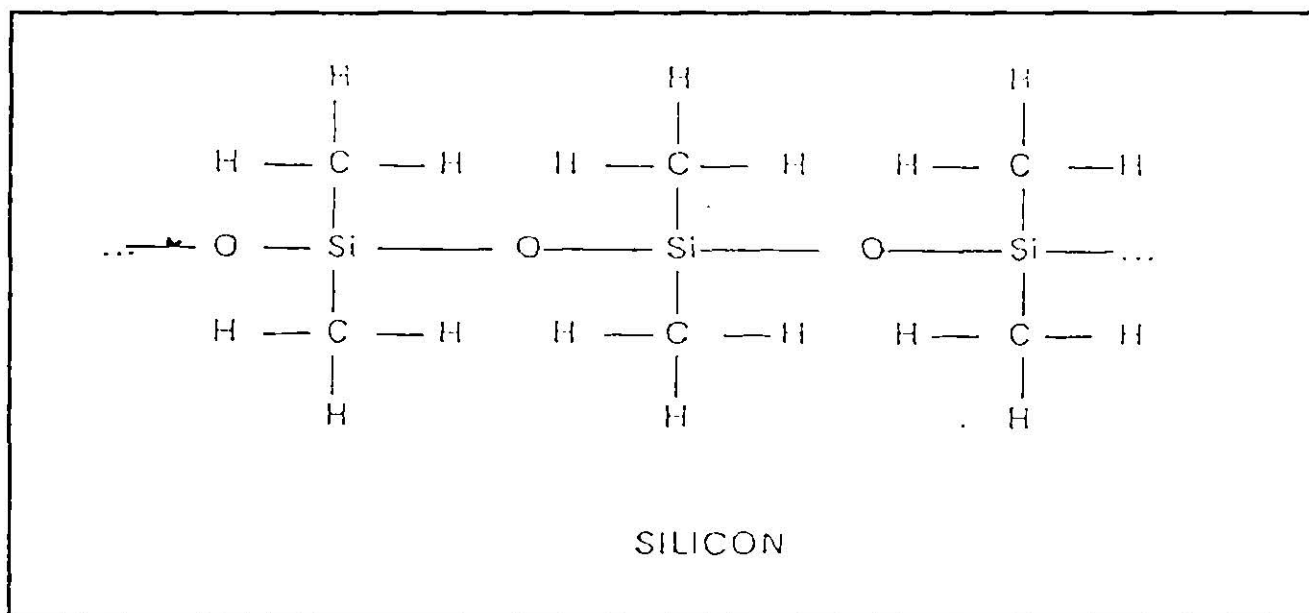

3.- Propiedades y Características Mecánicas en los Materiales

OBJETIVO DE LA PRÁCTICA: es el de conocer la manera de obtener las características y propiedades mecánicas básicas.

TEORÍA: basandonos en un ensaye estático de tensión y su gráfica de comportamiento esfuerzo vs deformación unitaria, obtendremos la siguientes características y propiedades mecánicas básicas en los materiales.

- * Resistencia Mecánica
- * Ductilidad
- * Rígidez
- * Resiliencia
- * Tenacidad
- * Estandares de Probetas
- * Velocidad del Ensayo
- * Textura de Grano y Tipos de Fallas

Resiliencia Mecánica: es la oposición que ofrece el material a traves de su fuerza interna (molecular) a la fuerza o carga aplicada.

Esta se mide a traves de:

1.- **Límite Proporcional ($\sigma_{L.P.}$):** es el mayor esfuerzo que un material es capaz de desarrollar sin perder la proporcionalidad entre esfuerzo y deformación, es decir, que representará el último punto en la pendiente de la gráfica, cumpliendo con la ley de hooke.

2.- **Límite Elástico ($\sigma_{L.E.}$):** es el mayor esfuerzo que un material es capaz de desarrollar sin que ocurra la deformación permanente al retirar el esfuerzo, la determinación de este límite elástico no es práctico y rara vez se realiza.

3.- Resistencia a la Cedencia ($\sigma_{Y.P.}$): es el esfuerzo al cual ocurre un aumento de deformación para cero incremento de esfuerzo.

En este punto cede el material a los defectos de cristal (vacancias, intersticios y dislocaciones) por lo que provoca el desplazamiento molecular (deformación) sin oponerse a la fuerza aplicada por lo que los incrementos de carga en la máquina de pruebas para algunos materiales.

4.- Resistencia Máxima (σ_{max}): es el esfuerzo máximo que puede desarrollar el material debido a la carga aplicada, durante un ensaye hasta la roptura. (Se observa en la probeta el inicio de la reducción de área en materiales dúctiles).

5.- Esfuerzo de Roptura ($\sigma_{RUP.}$): es el esfuerzo nominal al ocurrir falla y se obtiene dividiendo la carga decreciente registrada en la carátula o pantalla de la máquina y el área inicial de la probeta.

6.- Esfuerzo de Roptura Real o Verdadero ($\sigma_{RUP.}$): es el esfuerzo nominal al ocurrir la falla y se obtiene dividiendo la carga entre el área real que disminuye conforme se aplica ésta.

Este esfuerzo es improbable sobre la sección crítica o de falla, ya que el laminado del metal causa el desarrollo de una compleja distribución de esfuerzos.

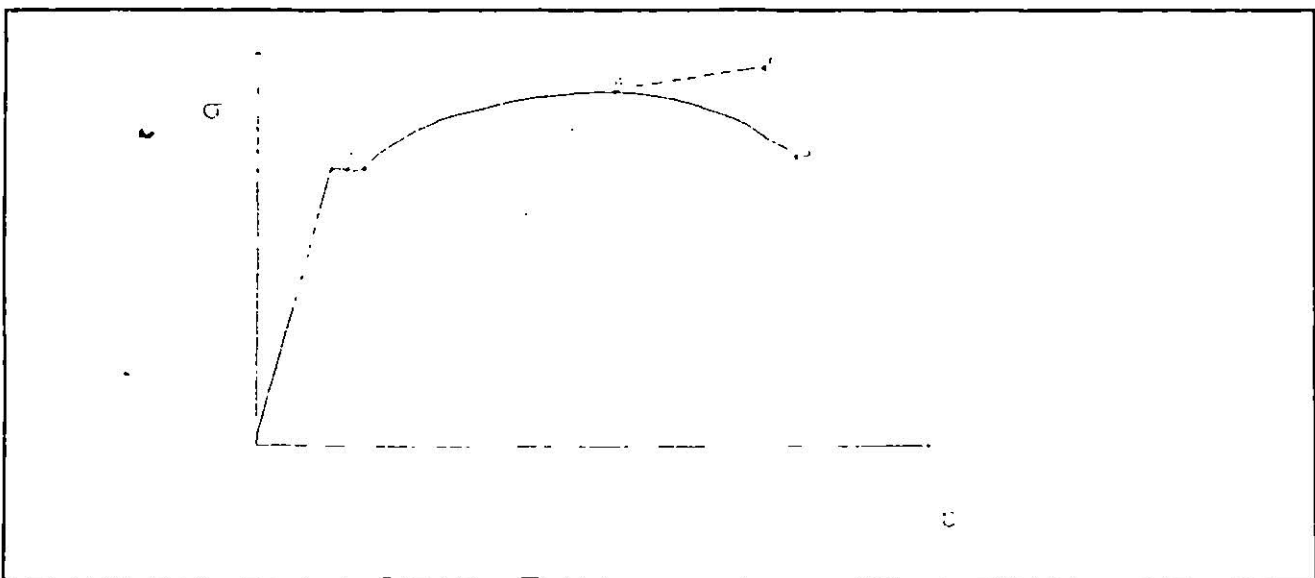

OBTENCIÓN DEL PUNTO DE CEDENCIA:

Se define como el esfuerzo al cual ocurre una gran deformación sin incremento de carga o esfuerzo.

En algunos materiales este punto de cedencia no se presenta como en otros, que a través de la oscilación de la aguja en la carátula de la lectura de carga o del canal en el display de carga, se puede detectar dicho punto en máquina universal.

El método para determinar el punto de cedencia se le conoce como método "offset" o "desplazamiento".

El método consiste en trazar una línea o recta paralela a la pendiente de la gráfica a partir de un valor de deformación unitaria de 0.001, 0.002, 0.003 in/in. Que representará 0.1%, 0.2%, 0.3% de deformación unitaria. El valor más usual es el 0.2% ver figura 3.2.



Figura 3.2

ZONAS EN LA GRÁFICA:

1.- **Zona Elástica:** se considera desde el origen hasta el punto límite proporcional. Se emplea en el diseño de elementos de máquinas y estructuras,

2.- **Zona Plástica:** se considera desde el punto de cedencia hasta el punto de esfuerzo máximo.

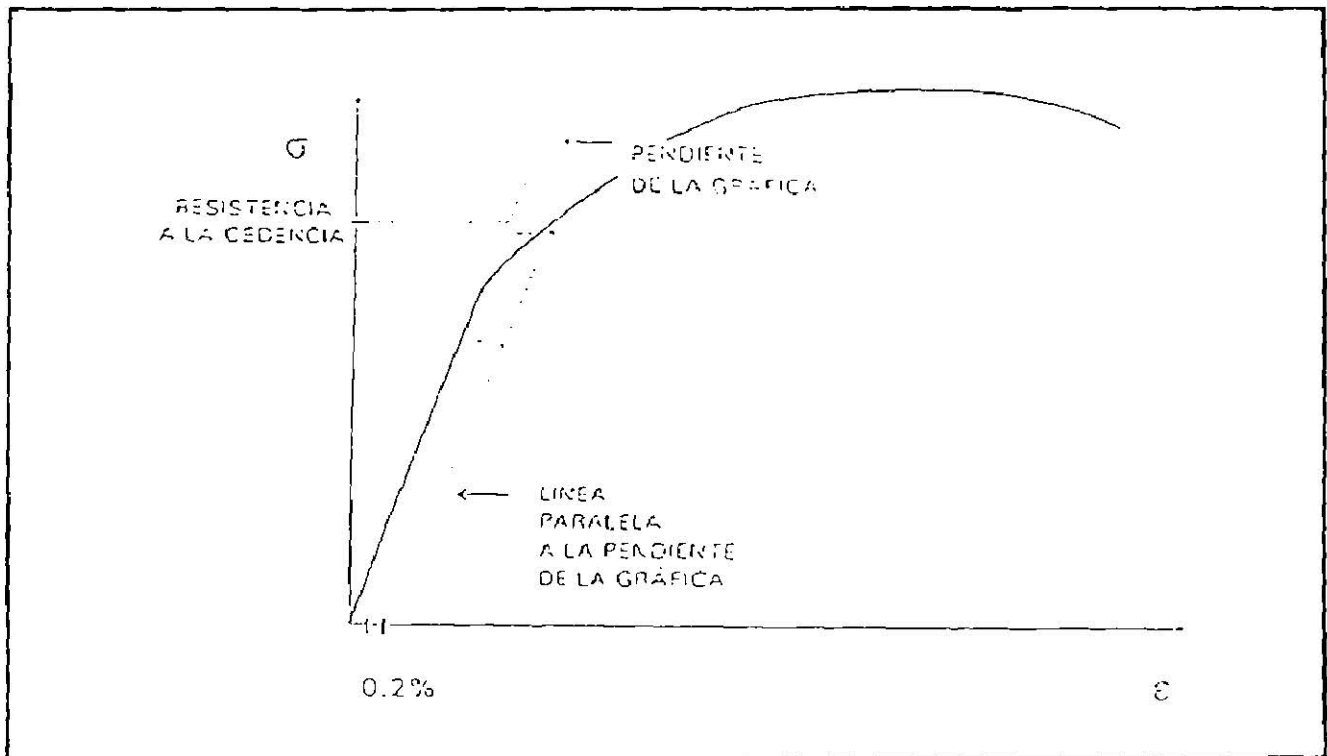
Se emplea para darle forma al material por ejemplo los procesos de mecanizado (torneado, troquelado, doblado, extruido, etc.), laminados (en caliente y en frío). Esta zona se divide: en zona de cedencia y zona de endurecimiento por deformación.

3.- **Zona Hiperplástica:** se considera en algunos materiales desde el punto de de esfuerzo máximo hasta el punto de roptura aparente.

Se emplea en el diseño de elementos de máquinas, productos y estructuras que deben absorber grandes cantidades de energía mecánica (energía cinética o potencial).



Figura 3.3

DUCTILIDAD

Es la propiedad que tienen los materiales de deformarse en grande.

FRAGILIDAD

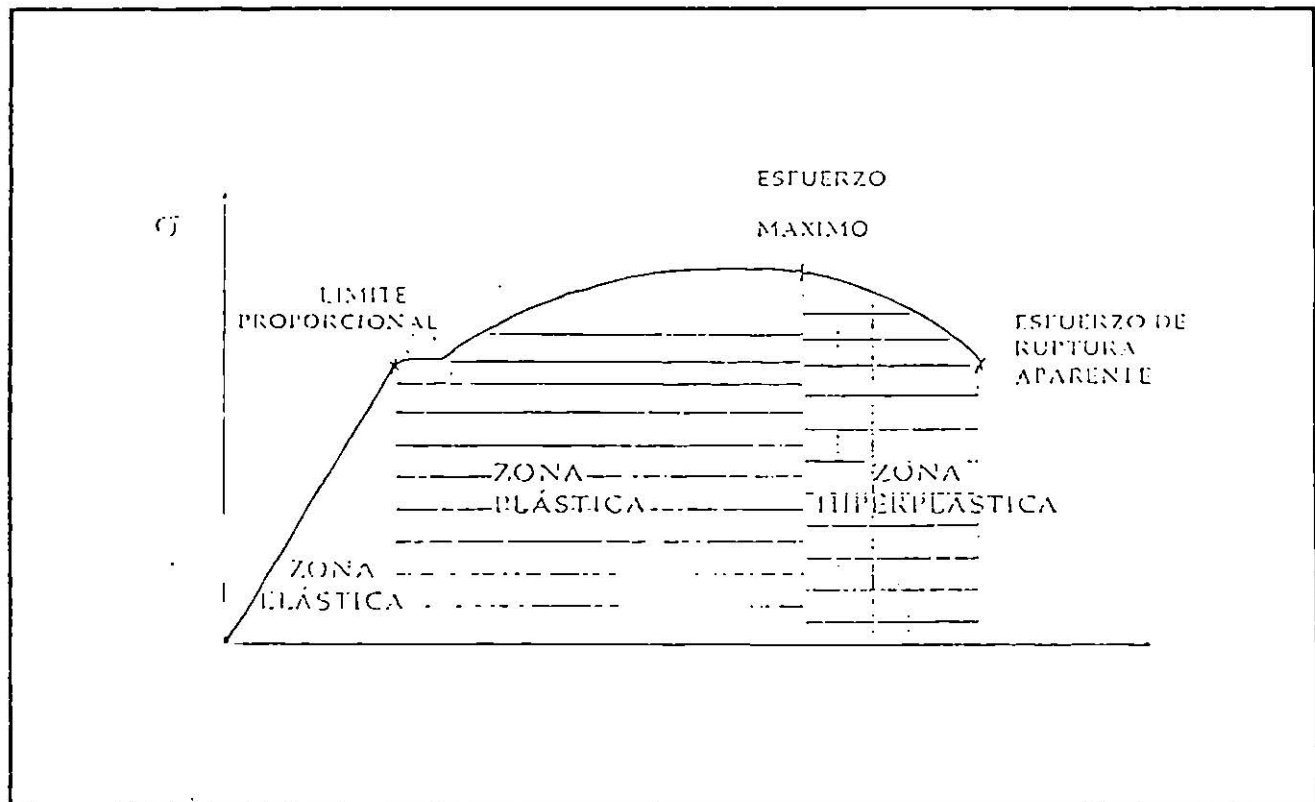
Es la propiedad que tienen los materiales de no presentar deformación macroscópica.

Estas propiedades son medidas:

* Para el Ensayo de Tensión a través de:

-**% de Elongación:** se obtiene midiendo la longitud inicial (L_0) y la final (L_f) de la probeta y luego sustituyendo en la ecuación:

$$\% \text{ Elong.} = (L_f - L_0) / L_0 \times 100$$

-**% de Reducción de Área:** se obtiene midiendo el diámetro inicial y final de la probeta, calculando el área respectiva y sustituyendo en la ecuación:

$$\% \text{ de Reducción de Área} = (A_0 - A_f) / A_0 \times 100$$

Para el Ensayo de Compresión a través de:

-**% de Aumento de Área:** se obtiene midiendo los diámetros inicial y final, calculando el área respectiva y sustituyendo en la ecuación:

$$\% \text{ de Aumento de Área} = (A_f - A_0) / A_0 \times 100$$

- **% de Reducción de Longitud:** se obtiene midiendo la longitud inicial y final de la probeta y sustituyendo en la ecuación:

$$\% \text{ de Reducción de Longitud} = (L_0 - L_f) / L_0 \times 100$$

Se recomienda que los materiales que tengan un % de elongación, % de reducción de área, % de aumento de área, % de reducción de longitud, mayor de 5 %, para que se consideren dúctiles.



Figura 3.4

RIGIDEZ:

Es el esfuerzo requerido para producir una deformación dada.

Se mide a través de la obtención del módulo de elasticidad para carga axial (E) y representa la tangente de la pendiente en la gráfica esfuerzo vs deformación, este modulo se puede obtener considerando dos puntos sobre la pendiente y realizando un triángulo como se muestra en la figura 3.5

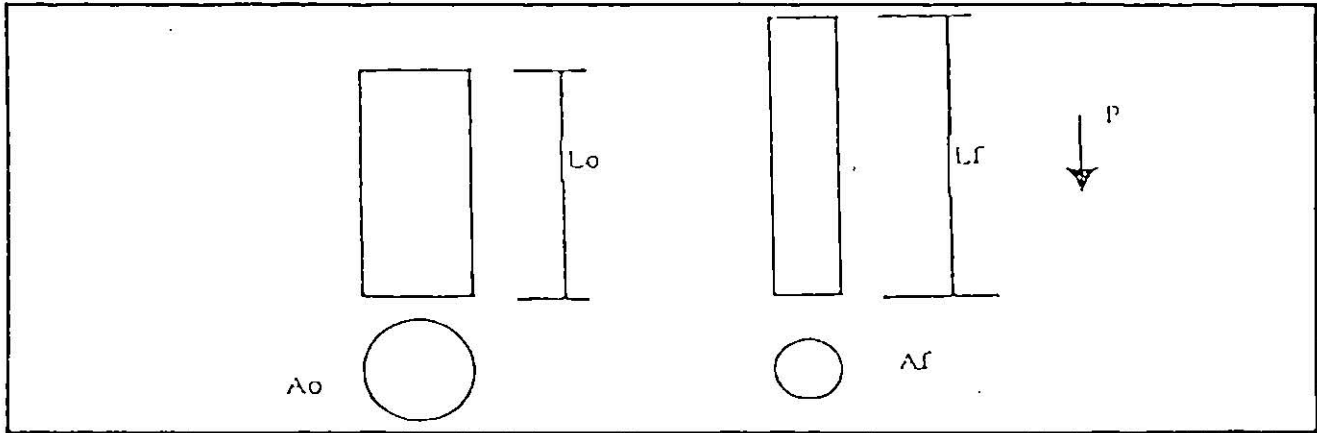
$$E = \text{Tg } \theta = \Delta\sigma / \Delta\varepsilon = (\sigma_2 - \sigma_1) / (\varepsilon_2 - \varepsilon_1)$$



Figura 3.5

Material	Modulo Elástico (E)		
	#	X10 ⁶ (kg / cm ²)	(MPa)
Acero Ordinario	2.1	200	30
Aluminio	0.705	70	10
Latón	0.98	100	11
Hierro Colado	1.05	120	11.6
Madera	0.09	183	1.2
Concreto	0.25	500	3.5
Plástico	0.56	116	0.8

Valores promedio de modulo de elasticidad de algunos materiales
 Tabla 1.1

RESILENCIA ELÁSTICA:

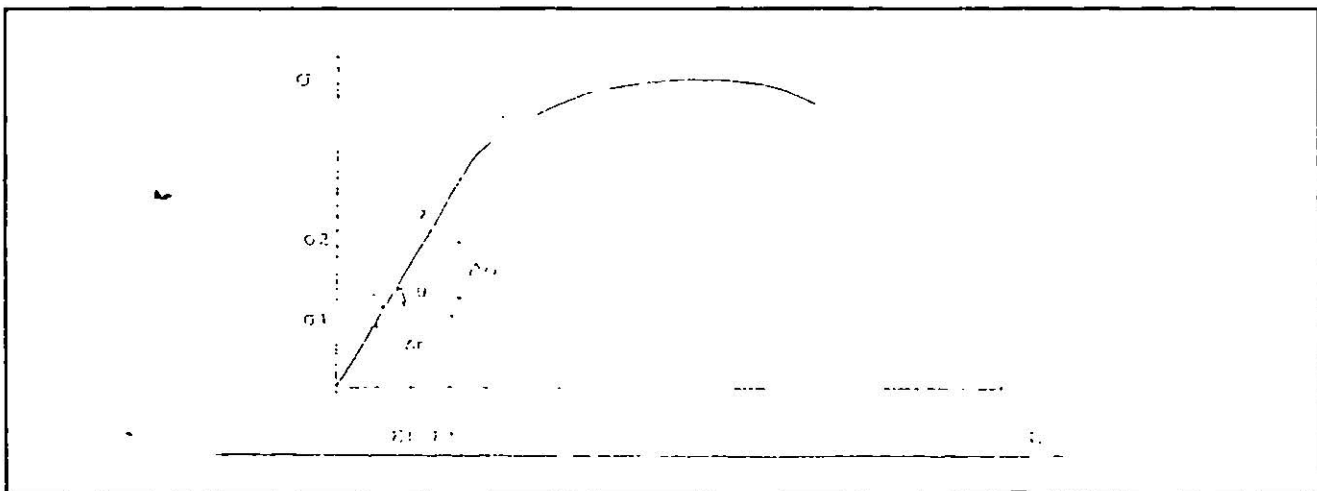
Es la propiedad que tienen los materiales de absorber energía hasta su límite proporcional o elástico (energía elástica).

Otras definiciones son: una medida de la resistencia a la energía elástica.

La resiliencia elástica unitaria (R.E.U.) o módulo de resiliencia: es la energía almacenada por unidad de volumen en límite elástico o proporcional; y representa el área (A1) bajo la pendiente de la gráfica σ vs ϵ mostrada en la figura 3.6.

$$REU = A1 = \sigma_{LP}^2 / 2\epsilon_{LP} \text{ (kg - cm / cm}^3\text{)}$$

$$\text{Volumen Inicial (Vo)} = A_0 \times L_0 \text{ (cm}^3\text{)}$$

$$\text{Resiliencia Elástica Total (RET)} = REU \times V_0.$$

$$RET = \sigma_{LP}^2 / 2\epsilon_{LP} \times V_0 \text{ (kg - cm)}$$

L.P.: Límite proporcional.



Figura 3.6

TENACIDAD:

Es la propiedad que tienen los materiales de absorber energía hasta el punto de rotura (energía plástica).

Representa el área total bajo la gráfica esfuerzo-deformación, esta se puede medir a través de seccionar el área en áreas regulares y sumarlas, o con el planimetro, que es un instrumento para determinar el área de una gráfica. Al seguir el contorno de la misma. El valor así obtenido será la tenacidad unitaria.

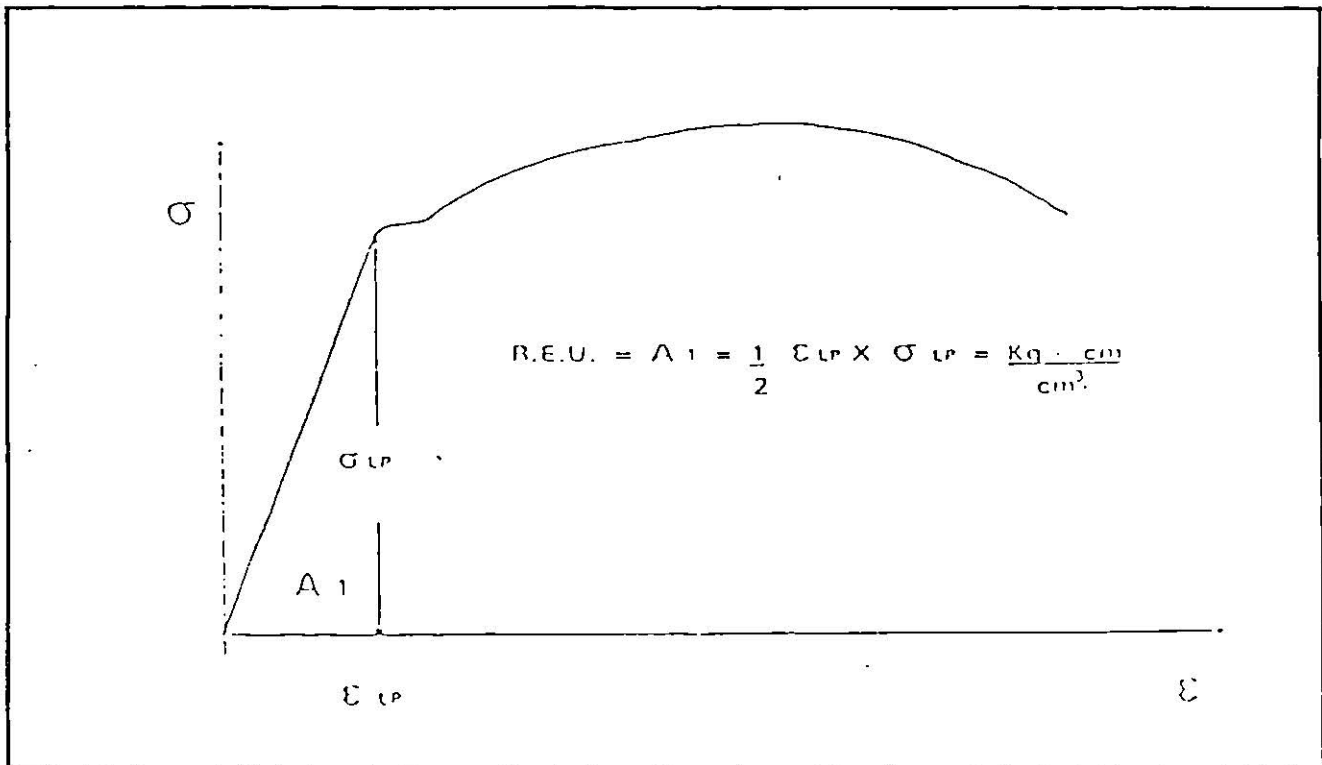
Tenacidad Unitaria (TU) = Área total

$$TU = (\sigma_{max} - \sigma_{YP}) \epsilon_{max} / 2 \text{ (kg - cm / cm}^3\text{)}$$

$$\text{Volumen Inicial (V}_0\text{)} = A_0 \times L_0 \text{ (cm}^3\text{)}$$

Tenacidad Total (TT) = TU x V₀ (kg - cm)

YP (Yield Point): Punto de cedencia.



Figura 3.6a

ESTANDAR DE PROBETAS PARA TENSIÓN:

Las probetas para ensayos de tensión se realizan de diferentes formas la sección transversal del espécimen puede ser redonda, rectangular o irregular según sea el caso.

Las formas dimensionales de la probeta depende de las asignaciones que estipule las normas referidas por las agencias de ensaye e inspección en los materiales y productos.

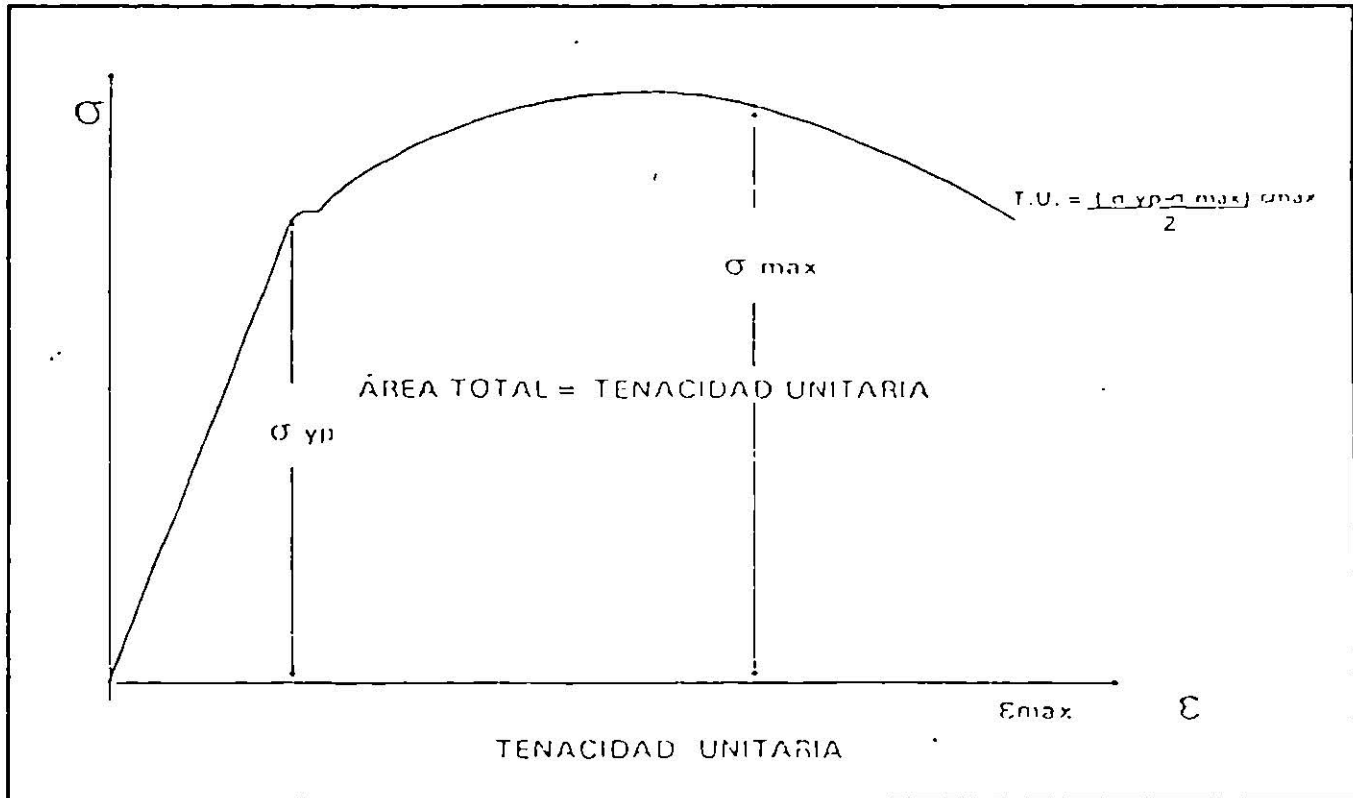
La porción del tramo recto es de sección menor que los extremos para provocar que la falla ocurra en una sección donde los esfuerzos no resulten afectados por los aditamentos de sujeción (ver figura 3.7).

El tramo de calibración es el marcado según estandar, sobre el cual se miden las lecturas de longitud final y diámetro final los extremos de las probetas redondas, y rectangulares, pueden ser simples, cabeceados o roscados, los extremos simples deben ser largos para adaptarse algún tipo de mordaza cuneiforme o plana (ver figura 3.8).



Figura 3.7



Figura 3.8

Una probeta debe ser simétrica con respecto a un eje longitudinal a lo largo de su longitud para evitar la flexión durante la aplicación de la carga (ver figura 3.8), la longitud de la sección reducida depende de la clase de material y de las mediciones que se tomen.

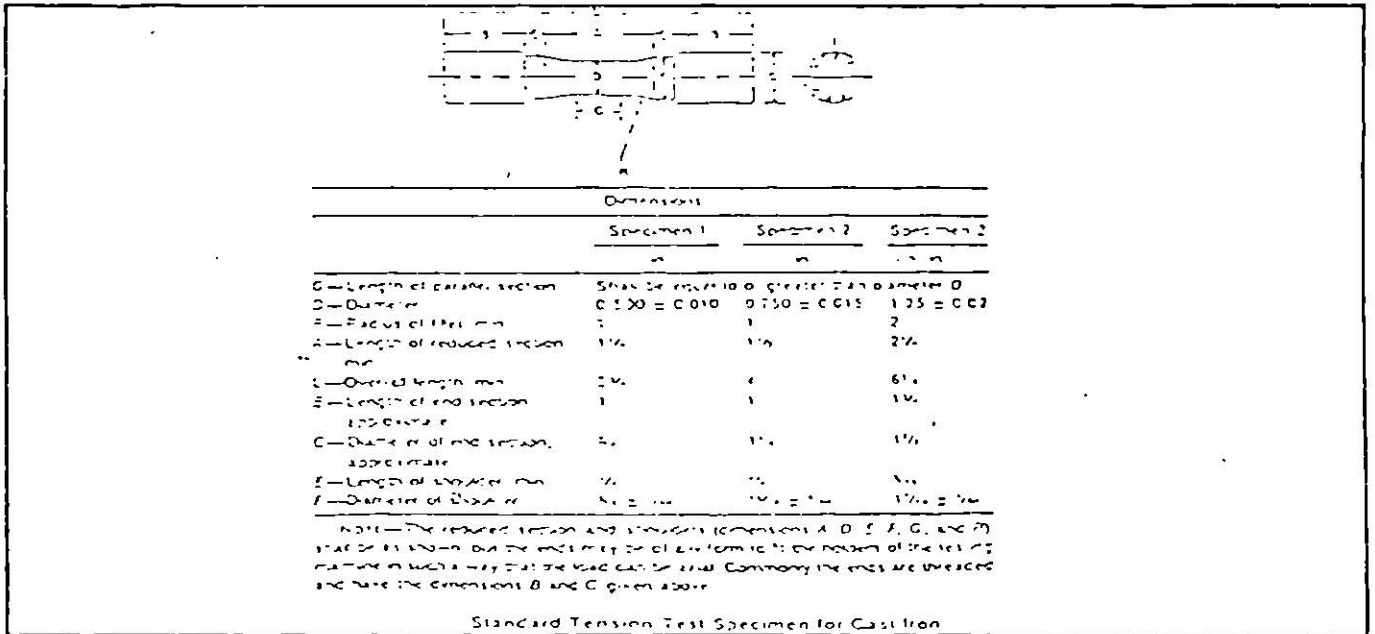
En las siguientes figuras 3.9 y 3.10 se muestran los diferentes estándares para los ensayos estáticos de tensión.

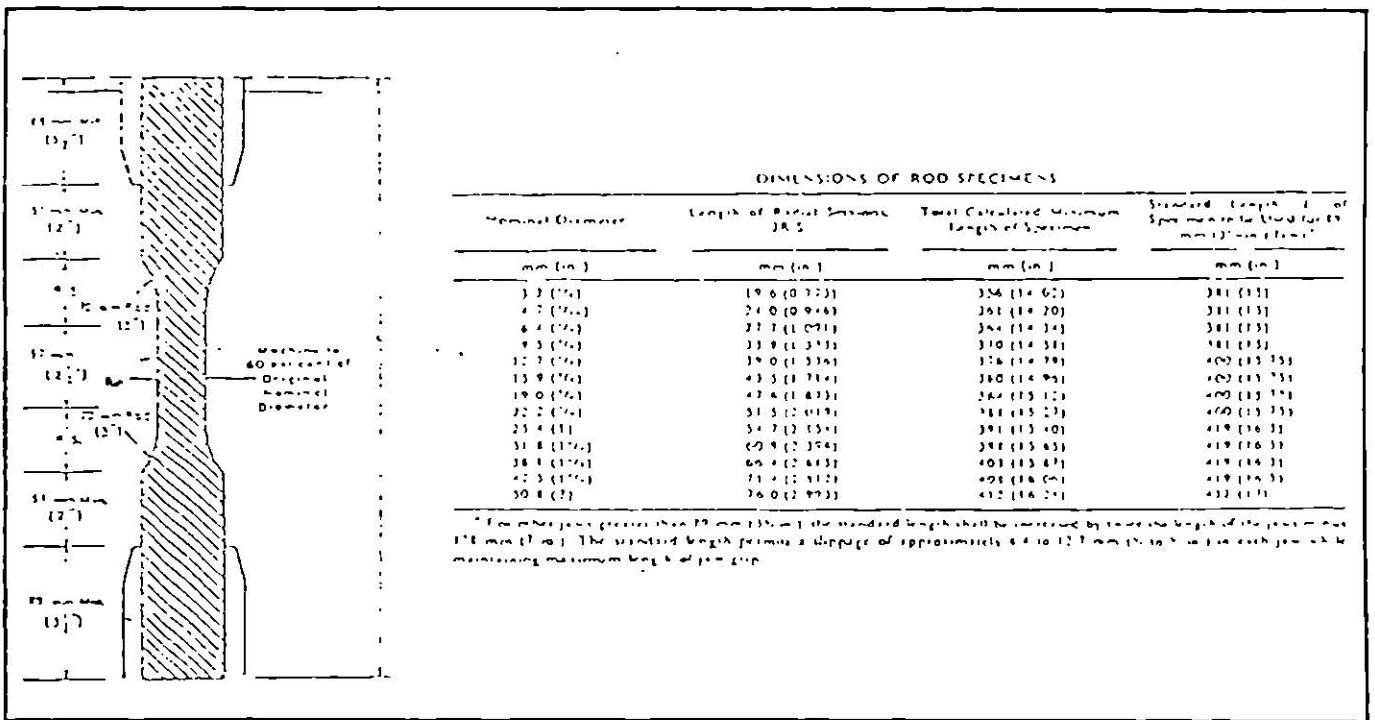

Figura 3.9

Specimen Dimensions for Tensile Testing						
Dimension (see drawings)	Specimen Diameter					Tolerances
	Type I	Type II	Type III	Type IV ¹	Type V	
H = Width of grip section ²	1.12	1.5	1.5	1.5	1.5	±0.02
L = Length of gauge section	1.52	1.52	1.52	1.52	1.52	±0.02
H G = Width over all min ²	1.12	1.5	1.5	1.5	1.5	±0
L G = Length over all min ²	1.52	1.52	1.52	1.52	1.52	±0.02
C = Grip length ²	1.52	1.52	1.52	1.52	1.52	±0.02
C = Grip length ²	1.52	1.52	1.52	1.52	1.52	±0.02
D = Diameter between grips	1.12	1.12	1.12	1.12	1.12	±0
R = Radius of fillet	1.5	1.5	1.5	1.5	1.5	±0
R O = Outer radius (Type IV)	1.5	1.5	1.5	1.5	1.5	±0

Specimen Dimensions for Tensile Testing						
Dimension (see drawings)	Specimen Diameter					Tolerances
	Type I	Type II	Type III	Type IV ¹	Type V	
H = Width of grip section ²	0.10	0.10	0.10	0.10	0.10	±0.02
L = Length of gauge section	0.10	0.10	0.10	0.10	0.10	±0.02
H G = Width over all min ²	0.10	0.10	0.10	0.10	0.10	±0.02
L G = Length over all min ²	0.10	0.10	0.10	0.10	0.10	±0.02
C = Grip length ²	0.10	0.10	0.10	0.10	0.10	±0.02
C = Grip length ²	0.10	0.10	0.10	0.10	0.10	±0.02
D = Diameter between grips	0.10	0.10	0.10	0.10	0.10	±0
R = Radius of fillet	0.10	0.10	0.10	0.10	0.10	±0.02
R O = Outer radius (Type IV)	0.10	0.10	0.10	0.10	0.10	±0.02

¹ Tensile Test Specimens for Steel, Cast, and Nonferrous Alloys

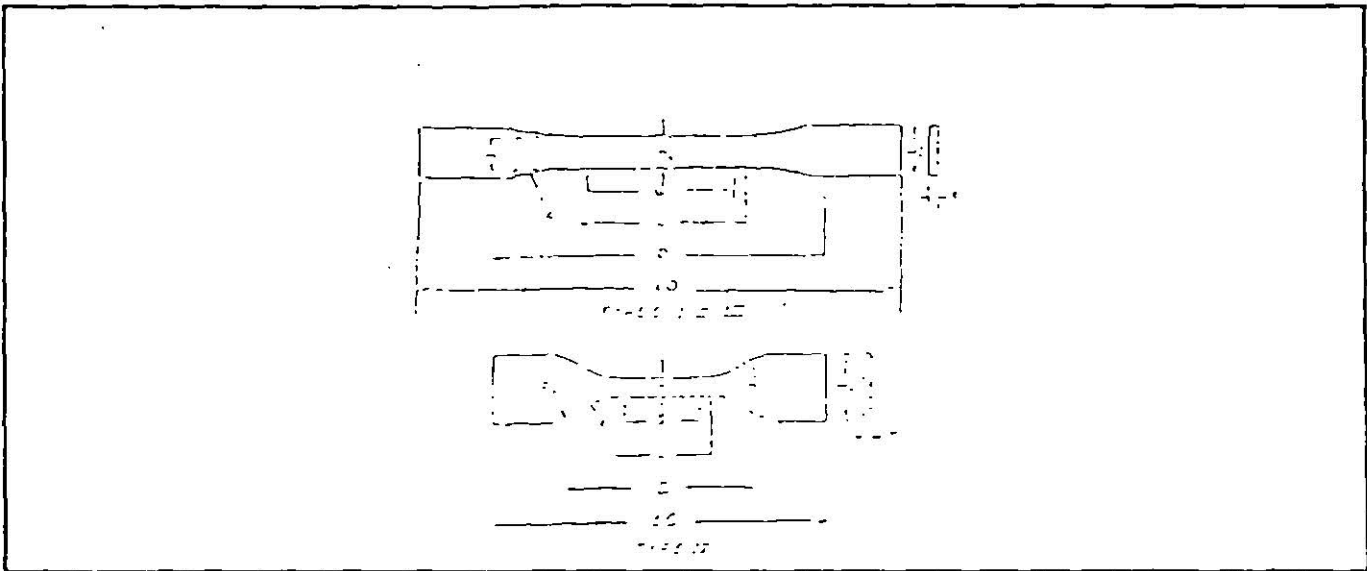
Figura 3.10

Otros estándares para polímeros o plásticos se encuentran en la asignación de la ASTM D 412, hasta D 530, hasta D 638; para concreto ASTM C 190; para materiales eléctricos ASTM D 651, etc.

VELOCIDAD EN ENSAYOS DE TENSIÓN

La velocidad de los ensayos a tensión serán aquellas que permitan las lecturas de carga y deformación o las que recomienden los estándares de la ASTM, ASME o alguna otra asociación. Para el tipo de material a ensayar, un ejemplo de velocidades del cabezal móvil serían desde 0.01 a 0.05 plg/min y una máxima velocidad de carga sería 100 kips/plg²-min, se sugiere detectar la cedencia en metales según ASTM 8.

TEXTURA DE GRANO Y TIPOS DE FRACTURA:

Las fracturas se pueden clasificar en cuanto a forma, textura y color de tipos de fracturas más comunes son cono-crater, parcialmente cono y crater, planas e irregulares y las que puedan definirse al momento de la fractura del espécimen los tipos de texturas son sedosa, grano fino, grano grueso, granular fibrosa, estillable, cristalina, vidriosa y mate y las que puedan determinarse al inspeccionar la sección transversal de la pieza (ver figura 3.11).



Figura 3.11

4.- Máquinas para Pruebas Mecánicas, Accesorios e Instrumentos de Medición

MÁQUINAS DE PRUEBAS MECÁNICAS

Las máquinas empleadas para las diferentes pruebas o ensayos en los materiales, en los diversos productos y pruebas experimentales.

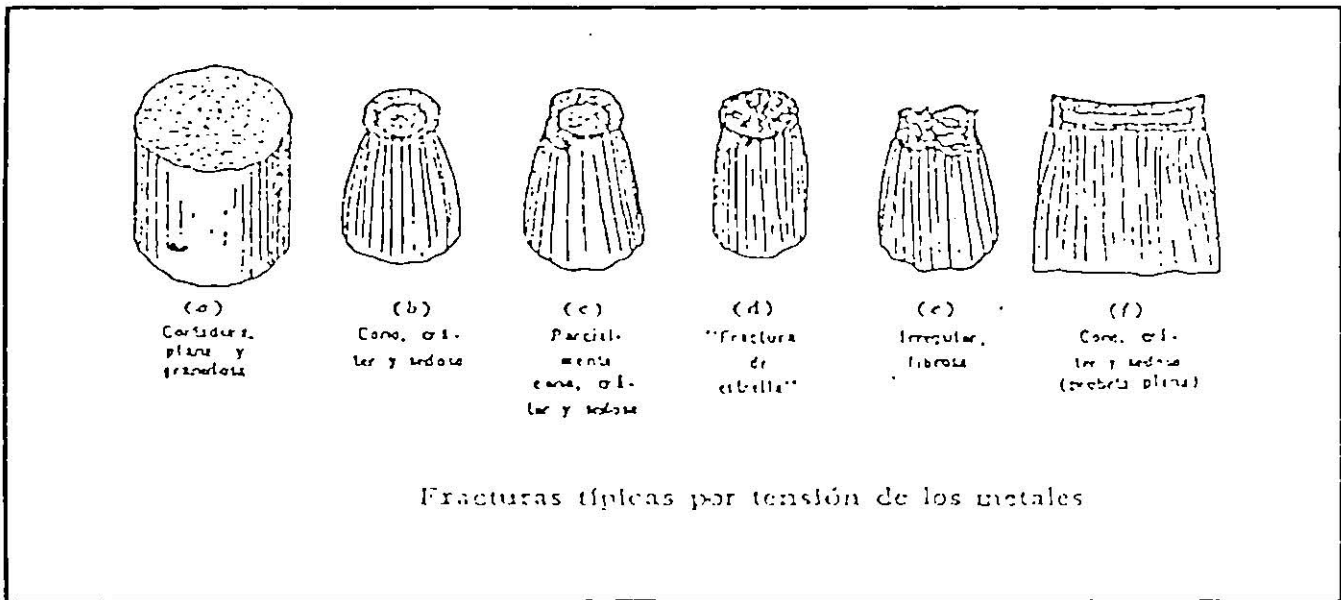
- * Máquina Universal de Pruebas
- * Máquina de Dureza Rockwell
- * Máquina de Dureza Brinell
- * Máquina de Ductilidad en la Mina Metálica
- * Máquina de Torsión
- * Máquina de Fatiga

Cada una de estas máquinas tiene sus correspondientes accesorios o aditamentos para la realización de los ensayos en los materiales, los cuales son recomendados por las agencias que normalizan los ensayos e inspección de los materiales.

Cuando se requiere probar algún producto, por lo común se tiene que hacer o diseñar el aditamento correspondiente. O en su caso lo que sugiera la norma del ensayo.

Enseguida se muestra los catálogos de las máquinas, accesorios y aditamentos.

**SE ANEXAN CATALOGOS RECIENTES DE LAS DIFERENTES.
EMPRESAS DISTRIBUIDORAS DE EQUIPO DE PRUEBAS MECÁNICAS**

NOTA:

Estas máquinas deben de estar en **buen estado, calibradas y certificadas** para su uso, esto dependerá de las recomendaciones que haga el fabricante de las mismas.

INSTRUMENTOS DE MEDICIÓN

Los instrumentos de medición que se requieren para obtener los datos iniciales y finales sobre el espécimen o muestra son:

- * **Calibrador para lecturas de dimensiones lineales de tipo:**
 1. Vernier
 2. De Carátula
 3. Digitales

- * **Cinta métrica o flexómetro**

- * **Calibrador de tipo micrometros** para la lectura de espesores interiores y exteriores.

- * **Extensómetro** para la medición de desplazamientos lineales de:
 1. Carátula
 2. Digitales

- * **Indicador de deformación (Puente de Wheatstone)** Considerando los **Straingages** o medidores de deformación eléctricos que se pegan o instrumentan en la pieza a probar para determinar la deformación punto por punto y en cualquier dirección que se desee o se requiera.

- * **Medidor de deformación eléctrico** para colocarlo directamente sobre el material y detectar a treves del graficador o en pantalla del monitor de la microcomputadora, si se tiene una máquina programable (automatizada por medio del software) el punto de cedencia del material a probar.

- * **Planímetro:** para la obtención de las áreas de la gráfica de esfuerzo contra deformación para determinar la resiliencia, tenacidad unitarios y pueden ser del tipo:
 1. Mecánico
 2. De Carátula
 3. Digital

NOTA:

Todos estos instrumentos de medición deben estar en **buen estado, calibrados y certificados** para su uso al igual que si tienen caducidad verificar su reposición ya que influyen en los resultados de las características dimensionales de la pieza o espécimen, al igual que en las propiedades y características mecánicas del material o producto.

BIBLIOGRAFÍA

1. ENSAYE E INSPECCION DE LOS MATERIALES.
AUTOR: DAVIS, TROXELL Y WISKOCIL.
EDITORIAL: H.A.R.L.A.

2. TOMOS DE LA A.S.T.M. PARA LOS METALES POLÍMEROS.

3. LA CIENCIA E INGENIERÍA DE LOS MATERIALES.
AUTOR: DONALD ASKELAND.

4. POLÍMEROS Y CERÁMICOS.
MEMORIAS DE SEMINARIO DE POLÍMEROS Y CERÁMICOS.

5. CATÁLOGOS MANUALES DE OPERACIÓN DE MÁQUINAS, ACCESORIOS Y ADITAMENTOS PARA CADA UNO DE LOS MATERIALES.
FABRICANTE: TINIUS OLSEN Pa. U.S.A.

6. EXPEDIENTE DE PRUEBAS MÉCANICAS A LA INDUSTRIA PARA DIVERSOS MATERIALES Y PRODUCTOS.
REALIZADAS POR: ING. DANIEL RAMÍREZ VLL. A TRAVES DE LOS LABORATORIOS DE PRUEBAS MECÁNICAS DE LA F.I.M.E.- U.A.N.L. (DESDE 1974 A LA FECHA).

7. MATERIALES PARA INGENIERÍA.
AUTOR: VAN BLACK.

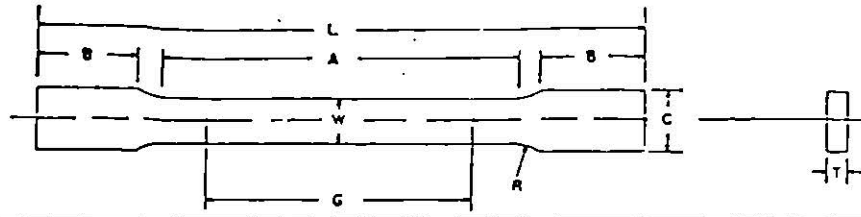

Dimensions, mm

Nominal Width	Standard Specimens		Subsize Specimen
	Plate-Type 40 mm	Sheet-Type 12.5 mm	6 mm
S—Gage length (Notes 1 and 2)	200.0 ± 0.2	50.0 ± 0.1	25.0 ± 0.1
W—Width (Notes 3 and 4)	40.0 ± 2.0	12.5 ± 0.2	6.0 ± 0.1
T—Thickness (Note 5)		thickness of material	
R—Radius of fillet, min (Note 6)	25	12.5	6
L—Overall length, min (Notes 2 and 7)	450	200	100
A—Length of reduced section, min	225	57	32
G—Length of grip section, min (Note 8)	75	50	30
C—Width of grip section, approximate (Notes 4 and 9)	50	20	10

NOTE 1—For the 40-mm wide specimen, punch marks for measuring elongation after fracture shall be made on the flat or on the edge of the specimen and within the reduced section. Either a set of nine or more punch marks 25 mm apart, or one or more pairs of punch marks 200 mm apart, may be used.

NOTE 2—When elongation measurements of 40-mm wide specimens are not required, a minimum length of reduced section (A) of 75 mm may be used with all other dimensions similar to the plate-type specimen.

NOTE 3—For the three sizes of specimens, the ends of the reduced section shall not differ in width by more than 0.10, 0.05 or 0.02 mm, respectively. Also, there may be a gradual decrease in width from the ends to the center, but the width at each end shall not be more than 1% larger than the width at the center.

NOTE 4—For each of the three sizes of specimens, narrower widths (W and C) may be used when necessary. In such cases the width of the reduced section should be as large as the width of the material being tested permits; however, unless stated specifically, the requirements for elongation in a product specification shall not apply when these narrower specimens are used.

NOTE 5—The dimension T is the thickness of the test specimen as provided for in the applicable material specifications. Minimum thickness of 40-mm wide specimens shall be 5 mm. Maximum thickness of 12.5-mm and 6-mm wide specimens shall be 19 mm and 6 mm, respectively.

NOTE 6—For the 40-mm wide specimen, a 13-mm minimum radius at the ends of the reduced section is permitted for steel specimens under 690 MPa in tensile strength when a profile cutter is used to machine the reduced section.

NOTE 7—To aid in obtaining axial loading during testing of 6-mm wide specimens, the overall length should be as large as the material will permit, up to 200 mm.

NOTE 8—It is desirable, if possible, to make the length of the grip section large enough to allow the specimen to extend into the grips a distance equal to two-thirds of the length of the grips. If the thickness of 12.5-mm wide specimens is over 10 mm, longer grips and correspondingly longer grip sections of the specimen may be necessary to prevent failure in the grip section.

NOTE 9—For the three sizes of specimens, the ends of the specimen shall be symmetrical in width with the center of the reduced section within ± 0.25, 0.10 and 0.10 mm, respectively. However, for referee testing and when required by product specifications, the ends of the 12.5-mm wide specimen shall be symmetrical within 0.2 mm.

NOTE 10—Specimens with sides parallel throughout their length are permitted, except for referee testing, provided: (a) the above tolerances are used; (b) an adequate number of marks are provided for determination of elongation; and (c) when yield strength is determined, a suitable extensometer is used. If the fracture occurs at a distance of less than 2W from the edge of the gripping device, the tensile properties determined may not be representative of the material. In acceptance testing, if the properties meet the minimum requirements specified, no further testing is required, but if they are less than the minimum requirements, discard the test and retest.

FIG. 1 Rectangular Tension Test Specimens

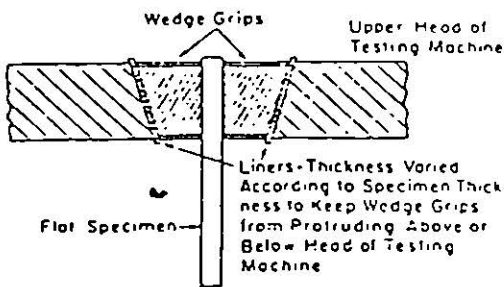

FIG. 2 Wedge Grips with Liners for Flat Specimens

7.10.3 The specimen's properties were changed because of poor machining practice,

7.10.4 The test procedure was incorrect,

7.10.5 The fracture was outside the gage length,

7.10.6 For elongation determinations, the fracture was outside the middle half of the gage length, or

7.10.7 There was a malfunction of the testing equipment.

NOTE 26—The tension specimen is inappropriate for assessing some types of imperfections in a material. Other methods and specimens employing ultrasonics, dye penetrants, radiography, etc., may be considered when flaws such as cracks, flakes, porosity, etc., are revealed during a test and soundness is a condition of acceptance.

8. Report

8.1 Test information on materials not covered by a product specification should be reported in accordance with 8.2 or both 8.2 and 8.3.

8.2 Test information to be reported shall include the following when applicable:

8.2.1 Material and sample identification.

8.2.2 Specimen type (Section 6).

8.2.3 Yield strength and the method used to determine yield strength (see 7.4).

8.2.4 Yield point and the method used to determine yield point (see 7.5).

8.2.5 Tensile strength (see 7.6).

8.2.6 Elongation (report both the original gage length and the percentage increase) (see 7.7).

8.2.7 Reduction of area (see 7.8).

8.3 Test information to be available on request shall include:

8.3.1 Specimen test section dimension(s).

8.3.2 Formula used to calculate cross-sectional area of specimens taken from large-diameter tubular products.

8.3.3 Speed and method used to determine speed of testing (see 7.3).

8.3.4 Method used for rounding of test results (see 7.9).

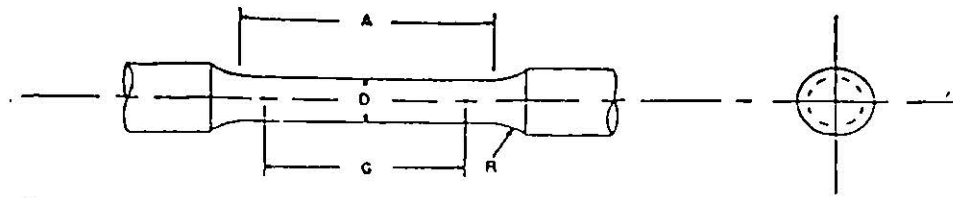

	Dimensions, mm				
	Standard Specimen	Small-Size Specimens Proportional To Standard			
	12.5	9	6	4	2.5
G—Gage length	62.5 ± 0.1	45.0 ± 0.1	30.0 ± 0.1	20.0 ± 0.1	12.5 ± 0.1
D—Diameter (Note 1)	12.5 ± 0.2	9.0 ± 0.1	6.0 ± 0.1	4.0 ± 0.1	2.5 ± 0.1
R—Radius of fillet, min	10	8	6	4	2
A—Length of reduced section, min (Note 2)	75	54	36	24	20

NOTE 1—The reduced section may have a gradual taper from the ends toward the center, with the ends not more than 1 % larger in diameter than the center (controlling dimension).

NOTE 2—If desired, the length of the reduced section may be increased to accommodate an extensometer of any convenient gage length. Reference marks for the measurement of elongation should, nevertheless, be spaced at the indicated gage length.

NOTE 3—The gage length and fillets shall be as shown, but the ends may be of any form to fit the holders of the testing machine in such a way that the load may be axial (see Fig. 9). If the ends are to be held in wedge grips it is desirable, if possible, to make the length of the grip section great enough to allow the specimen to extend into the grips a distance equal to two thirds or more of the length of the grips.

NOTE 4—On the round specimens in Figs. 8 and 9, the gage lengths are equal to five times the nominal diameter. In some product specifications other specimens may be provided for, but the 5-to-1 ratio is maintained within dimensional tolerances, the elongation values may not be comparable with those obtained from the standard test specimen.

NOTE 5—The use of specimens smaller than 6 mm in diameter shall be restricted to cases when the material to be tested is of insufficient size to obtain larger specimens or when all parties agree to their use for acceptance testing. Smaller specimens require suitable equipment and greater skill in both machining and testing.

FIG. 8 Standard 12.5-mm Round Tension Test Specimen with Gage Lengths Five Times the Diameters (5D), and Examples of Small-Size Specimens Proportional to the Standard Specimen

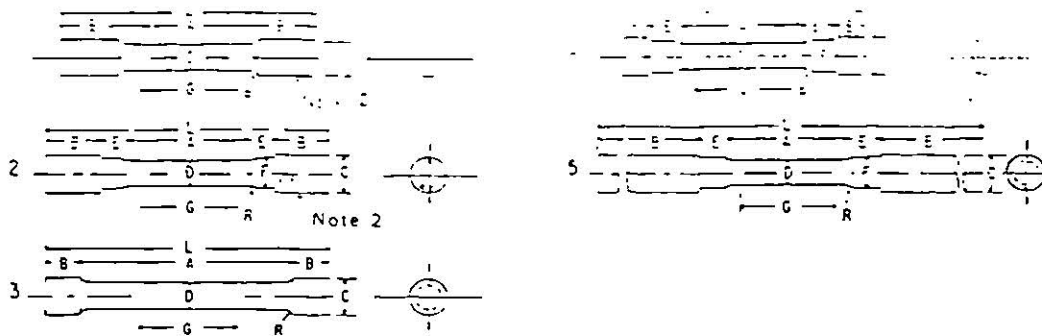

	Dimensions, mm				
	Specimen 1	Specimen 2	Specimen 3	Specimen 4	Specimen 5
G—Gage length	62.5 ± 0.1	62.5 ± 0.1	62.5 ± 0.1	62.5 ± 0.1	62.5 ± 0.1
D—Diameter (Note 1)	12.5 ± 0.2	12.5 ± 0.2	12.5 ± 0.2	12.5 ± 0.2	12.5 ± 0.2
R—Radius of fillet, min	10	10	2	10	10
A—Length of reduced section	75, min	75, min	100, approximately	75, min	75, min
L—Overall length, approximate	145	155	140	140	255
B—Length of end section (Note 3)	35, approximately	25, approximately	20, approximately	15, approximately	75, min
C—Diameter of end section	20	20	20	22	20
E—Length of shoulder and fillet section, approximate	15	20	15
F—Diameter of shoulder	15	15	15

NOTE 1—The reduced section may have a gradual taper from the ends toward the center with the ends not more than 1 % larger in diameter than the center.

NOTE 2—On Specimens 1 and 2, any standard thread is permissible that provides for proper alignment and aids in assuring that the specimen will break within the reduced section.

NOTE 3—On Specimen 5 it is desirable, if possible, to make the length of the grip section great enough to allow the specimen to extend into the grips a distance equal to two thirds or more of the length of the grips.

FIG. 9 Various Types of Ends for Standard Round Tension Test Specimens

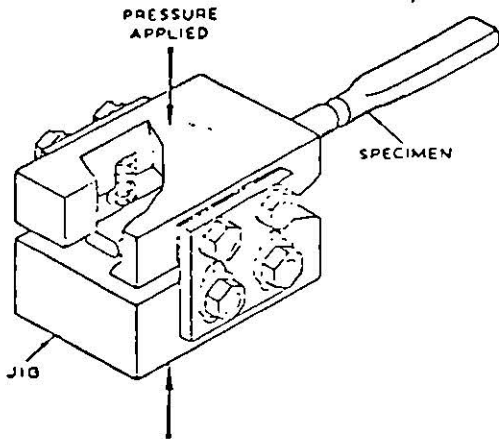
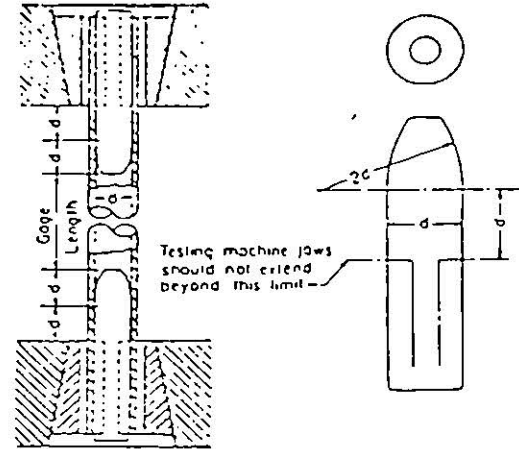
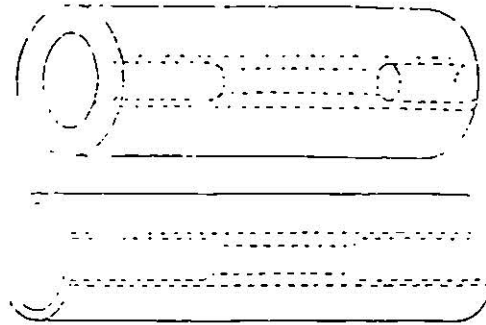

FIG. 10 Squeezing Jig for Flattening Ends of Full-Size Tension Test Specimens



NOTE—The diameter of the plug shall have a slight taper from the line limiting the testing machine jaws to the curved section.

FIG. 11 Metal Plugs for Testing Tubular Specimens, Proper Location of Plugs in Specimen and of Specimen in Heads of Testing Machine



NOTE—The edges of the blank for the specimen shall be cut parallel to each other.

FIG. 12 Location from Which Longitudinal Tension Test Specimens Are to Be Cut from Large-Diameter Tube

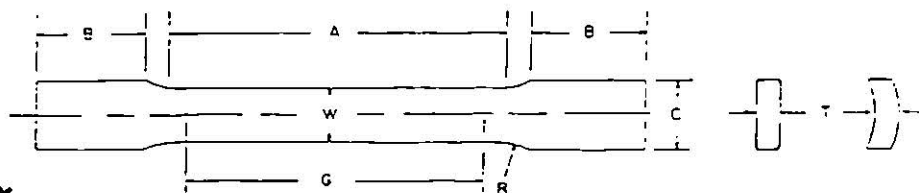

Dimensions, mm

Nominal Width	Specimen 1	Specimen 2	Specimen 3
	12.5	40	40
G—Gage length	50.0 ± 0.1	50.0 ± 0.1	200.0 ± 0.2
W—Width (Note 1)	12.5 ± 0.2	40.0 ± 2.0	40.0 ± 2.0
T—Thickness	measured thickness of specimen		
R—Radius of fillet, min	12.5	25	25
A—Length of reduced section, min	60	60	230
B—Length of grip section, min (Note 2)	75	75	75
C—Width of grip section, approximate (Note 3)	20	50	50

NOTE 1—The ends of the reduced section shall not differ in width by more than 0.1 mm for specimens 1, 2, and 3. There may be a gradual taper in width from the ends to the center, but the width at each end shall be not more than 1% greater than the width at the center.

NOTE 2—It is desirable, if possible, to make the length of the grip section great enough to allow the specimen to extend into the grips a distance equal to two thirds or more of the length of the grips.

NOTE 3—The ends of the specimen shall be symmetrical with the center line of the reduced section within 1.0 mm for specimen 1 and 2.5 mm for specimens 2 and 3.

NOTE 4—Specimens with sides parallel throughout their length are permitted, except for referee testing and where prohibited by product specification, provided: (a) the above tolerances are used; (b) an adequate number of marks are provided for determination of elongation; and (c) when yield strength is determined, a suitable extensometer is used. If the fracture occurs at a distance of less than 2W from the edge of the gripping device, the tensile properties determined may not be representative of the material. If the properties meet the minimum requirements specified, no further testing is required, but if they are less than the minimum requirements, discard the test and retest.

FIG. 13 Tension Test Specimens for Large-Diameter Tubular Products

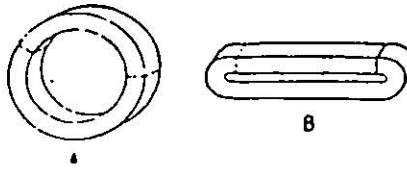
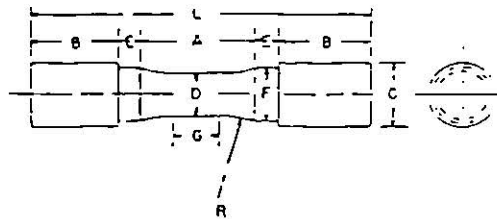

FIG. 14 Location of Transverse Tension Test Specimen in Ring Cut from Tubular Products



Dimensions, mm

Nominal Diameter	Dimensions, mm		
	Specimen 1	Specimen 2	Specimen 3
	12.5	20	30
G—Length of parallel section	Shall be equal to or greater than diameter D		
D—Diameter	12.5 = 0.2	20.0 = 0.4	30.0 = 0.5
R—Radius of fillet, min	25	25	50
A—Length of reduced section, min	32	38	60
L—Overall length, min	95	100	160
B—Length of end section, approximate	25	25	45
C—Diameter of end section, approximate	20	30	48
E—Length of shoulder, min	6	6	6
F—Diameter of shoulder	16.0 = 0.4	24.0 = 0.4	36.5 = 0.4

NOTE—The reduced section and shoulders (dimensions A, D, E, F, G, and R) shall be as shown, but the ends may be of any form to fit the holders of the testing machine in such a way that the load shall be axial. Commonly the ends are threaded and have the dimensions B and C given above.

FIG. 15 Standard Tension Test Specimen for Cast Iron

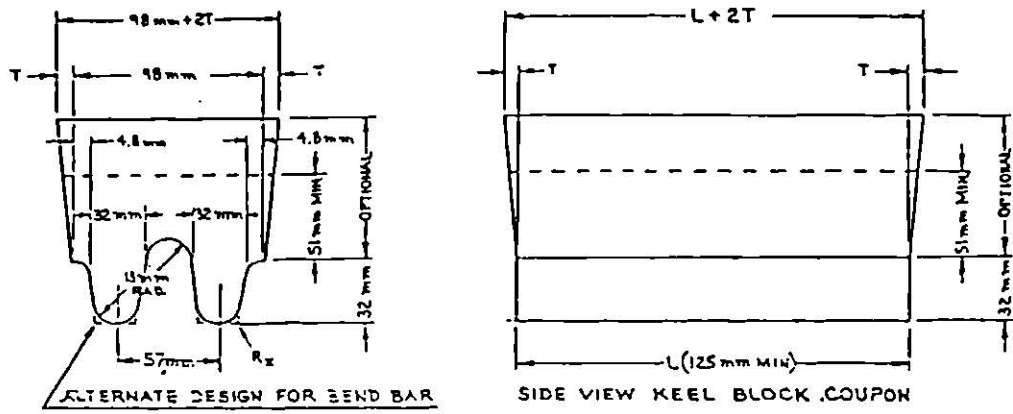

(a) Design for Double Keel Block Coupon

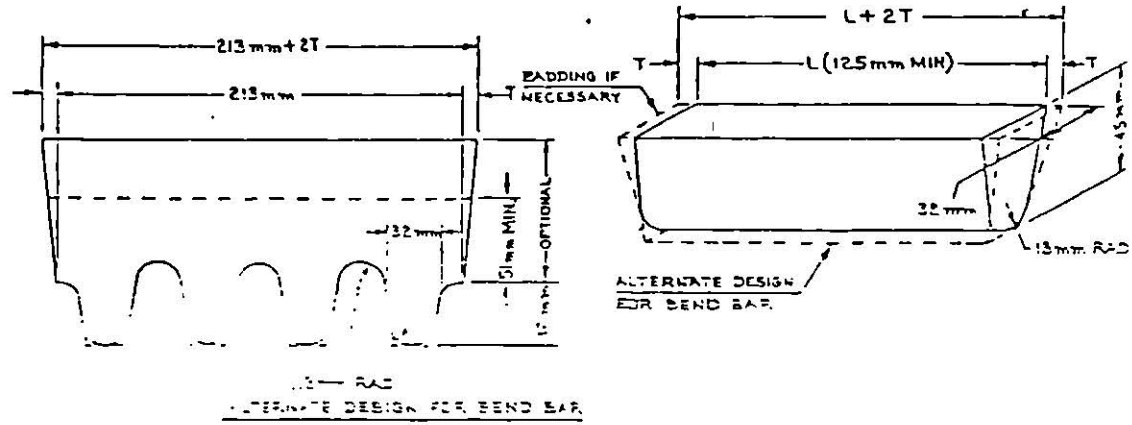

(b) Design for Multiple Keel Block Coupon (4 Legs)

(c) Design for "Attached" Coupon

FIG. 16 Test Coupons for Castings (see Table 1 for Details of Design)

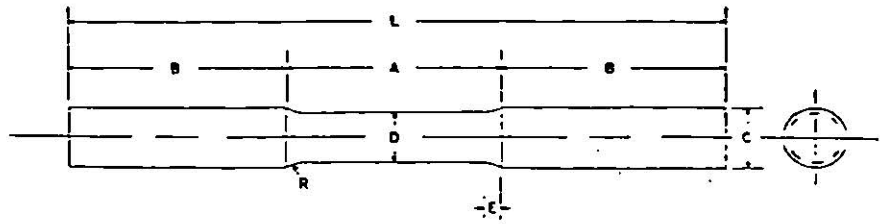

Dimensions, mm	
D—Diameter	16
R—Radius of fillet	8
A—Length of reduced section	64
L—Overall length	190
B—Length of end section	64
C—Diameter of end section	20
E—Length of fillet	5

FIG. 17 Standard Tension Test Specimen for Malleable Iron

Hardness vs Minimum Thickness Chart 55

Any greater thickness and hardness can be safely tested on indicated scale	Rockwell Superficial Hardness Scales			Rockwell Regular Hardness Scales		
	15N	30N	45N	A	D	C
	15 kgf	30 kgf	45 kgf	60 kgf	100 kgf	150 kgf
Thickness inches (mm)	N Brale Indenter			Brale Indenter		
.006 (0.15)	92	—	—	—	—	—
.009 (0.20)	90	—	—	—	—	—
.010 (0.25)	88	—	—	—	—	—
.012 (0.30)	83	82	77	—	—	—
.014 (0.36)	76	78.5	74	—	—	—
.016 (0.41)	68	74	72	86	—	—
.018 (0.46)	X	66	68	84	—	—
.020 (0.51)	X	57	63	82	77	—
.022 (0.56)	X	47	58	79	75	69
.024 (0.61)	X	X	51	76	72	67
.026 (0.66)	X	X	37	71	68	65
.028 (0.71)	X	X	20	67	63	62
.030 (0.76)	X	X	X	60	58	57
.032 (0.81)	X	X	X	X	51	52
.034 (0.86)	X	X	X	X	43	45
.036 (0.91)	X	X	X	X	X	37
.038 (0.96)	X	X	X	X	X	28
.040 (1.02)	X	X	X	X	X	20
Any greater thickness and hardness can be safely tested on indicated scale	Rockwell Superficial Hardness Scales			Rockwell Regular Hardness Scales		
	15-T	30-T	45-T	F	B	G
	15 kgf	30 kgf	45 kgf	60 kgf	100 kgf	150 kgf
Thickness inches (mm)	1/16" Ball Indenter			1/16" Ball Indenter		
.010 (0.25)	91	—	—	—	—	—
.012 (0.30)	86	—	—	—	—	—
.014 (0.36)	81	80	—	—	—	—
.016 (0.41)	75	72	71	—	—	—
.018 (0.46)	68	64	62	—	—	—
.020 (0.51)	X	55	53	—	—	—
.022 (0.56)	X	45	43	—	—	—
.024 (0.61)	X	X	35	85	82	74
.026 (0.66)	X	X	25	81	87	87
.028 (0.71)	X	X	—	85	80	78
.030 (0.76)	X	X	X	77	71	68
.032 (0.81)	X	X	X	69	62	59
.034 (0.86)	X	X	X	X	52	50
.036 (0.91)	X	X	X	X	40	42
.038 (0.96)	X	X	X	X	28	31
.040 (1.02)	X	X	X	X	X	22

X No Minimum Hardness

These values are approximate only and this chart is intended primarily as a guide.

Materials thinner than shown in this chart may be tested on the Tukon[®] microhardness tester. The thickness of the specimen should be at least 1 1/2 times the diagonal of the indentation when using the Vickers (136°) diamond pyramid indenter, and at least 1/2 times the long diagonal when using the Knoop indenter.

Note 3. Values in Chart 55 are consistent with ASTM E18 Tables 4, 5, 11 and 12 except for D and G-scale values which appear in Indentation Hardness Testing by Vincent E. Lysaght, © 1968 Wilson Instrument Division, Acco

Cylindrical Correction Chart 53

Cylindrical work corrections to be added to observed Rockwell Number for Scales Indicated

Scales C, D, A										
Observed Reading	Brale Diamond Indenter Diameter of specimen — inches (mm)									
	1/8 (3.2)	1/4 (6.4)	3/8 (10)	1/2 (13)	5/8 (16)	3/4 (19)	7/8 (22)	1 (25)	1-1/4 (32)	1-1/2 (38)
90	NA	0.5	0	0	0	0	0	0	0	0
85		0.5	0.5	0.5	0	0	0	0	0	0
80		0.5	0.5	0.5	0.5	0.5	0	0	0	0
75		1.0	0.5	0.5	0.5	0.5	0.5	0	0	0
70		1.0	1.0	0.5	0.5	0.5	0.5	0.5	0	0
65		1.5	1.0	1.0	0.5	0.5	0.5	0.5	0	0
60		1.5	1.0	1.0	0.5	0.5	0.5	0.5	0	0
55		2.0	1.5	1.0	1.0	0.5	0.5	0.5	0.5	0
50		2.5	2.0	1.5	1.0	1.0	0.5	0.5	0.5	0.5
45		3.0	2.0	1.5	1.0	1.0	1.0	0.5	0.5	0.5
40		3.5	2.5	2.0	1.5	1.0	1.0	1.0	0.5	0.5
35		4.0	3.0	2.0	1.5	1.5	1.0	1.0	0.5	0.5
30		5.0	3.5	2.5	2.0	1.5	1.5	1.0	1.0	0.5
25		5.5	4.0	3.0	2.5	2.0	1.5	1.0	1.0	1.0
20		6.0	4.5	3.5	2.5	2.0	1.5	1.5	1.0	1.0

Scales B, F, G										
Observed Reading	1/16" Ball Indenter Diameter of specimen — inches (mm)									
	1/8 (3.2)	1/4 (6.4)	3/8 (10)	1/2 (13)	5/8 (16)	3/4 (19)	7/8 (22)	1 (25)	1-1/4 (32)	1-1/2 (38)
100	NA	3.5	2.5	1.5	1.5	1.0	1.0	0.5	NA	NA
90		4.0	3.0	2.0	1.5	1.5	1.5	1.0		
80		5.0	3.5	2.5	2.0	1.5	1.5	1.5		
70		6.0	4.0	3.0	2.5	2.0	2.0	1.5		
60		7.0	5.0	3.5	3.0	2.5	2.0	2.0		
50		8.0	5.5	4.0	3.5	3.0	2.5	2.0		
40		9.0	6.0	4.5	4.0	3.0	2.5	2.5		
30		10.0	6.5	5.0	4.5	3.5	3.0	2.5		
20		11.0	7.5	5.5	4.5	4.0	3.5	3.0		
10		12.0	8.0	6.0	5.0	4.0	3.5	3.0		
5		12.5	8.5	6.5	5.5	4.5	3.5	3.0		

Scales 15-N, 30-N, 45-N										
Observed Reading	Brale Diamond Indenter Diameter of specimen — inches (mm)									
	1/8 (3.2)	1/4 (6.4)	3/8 (10)	1/2 (13)	5/8 (16)	3/4 (19)	7/8 (22)	1 (25)	1-1/4 (32)	1-1/2 (38)
90	0	0	0	0	0	0	0	0	NA	NA
85	0.5	0.5	0.5	0.5	0	0	0	0		
80	1.0	0.5	0.5	0.5	0.5	0	0	0		
75	1.5	1.0	0.5	0.5	0.5	0.5	0	0		
70	2.0	1.0	1.0	0.5	0.5	0.5	0.5	0.5		
65	2.5	1.5	1.0	0.5	0.5	0.5	0.5	0.5		
60	3.0	1.5	1.0	1.0	1.0	0.5	0.5	0.5		
55	3.5	2.0	1.5	1.0	1.0	0.5	0.5	0.5		
50	3.5	2.0	1.5	1.0	1.0	1.0	1.0	0.5		
45	4.0	2.0	1.5	1.0	1.0	1.0	1.0	1.0		
40	4.5	2.5	1.5	1.5	1.0	1.0	1.0	1.0		
35	5.0	2.5	2.0	1.5	1.0	1.0	1.0	1.0		
30	5.5	3.0	2.0	1.5	1.5	1.0	1.0	1.0		
25	5.5	3.0	2.0	1.5	1.5	1.5	1.5	1.0		
20	5.0	3.0	2.0	1.5	1.5	1.5	1.5	1.5		

Scales 15-T, 30-T, 45-T										
Observed Reading	1/16" Ball Indenter Diameter of specimen — inches (mm)									
	1/8 (3.2)	1/4 (6.4)	3/8 (10)	1/2 (13)	5/8 (16)	3/4 (19)	7/8 (22)	1 (25)	1-1/4 (32)	1-1/2 (38)
90	1.5	1.0	1.0	0.5	0.5	0.5	0.5	0.5	NA	NA
80	3.0	2.0	1.5	1.5	1.0	1.0	1.0	0.5		
70	5.0	3.5	2.5	2.0	1.5	1.0	1.0	1.0		
60	6.5	4.5	3.0	2.5	2.0	1.5	1.5	1.5		
50	8.5	5.5	4.0	3.0	2.5	2.0	2.0	1.5		
40	10.0	6.5	4.5	3.5	3.0	2.5	2.0	2.0		
30	11.5	7.5	5.0	3.5	3.5	2.5	2.0	2.0		
20	13.0	9.0	6.0	4.5	4.5	3.0	2.0	2.0		

These corrections are approximate only and represent the averages, to the nearest 1/2 Rockwell number, of numerous actual observations.

These values are consistent with ASTM E18 Tables 6, 7, 13 and 14.

When testing cylindrical specimens, the accuracy of the test will be seriously affected by alignment of elevating screw, Vee anvil, indenters, surface finish and the straightness of the cylinder.

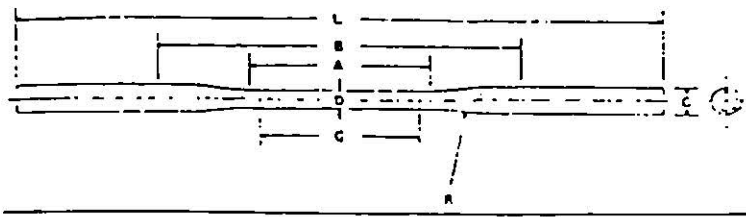

Dimensions, mm

G—Gage length	50.0 ± 0.1
D—Diameter (see Note)	6.4 ± 0.1
R—Radius of fillet, min	75
A—Length of reduced section, min	60
L—Overall length, min	230
B—Distance between gnps, min	115
C—Diameter of end section, approximate	10

NOTE—The reduced section may have a gradual taper from the ends toward the center, with the ends not more than 0.1 mm larger in diameter than the center.

FIG. 18 Standard Tension Test Specimen for Die Castings

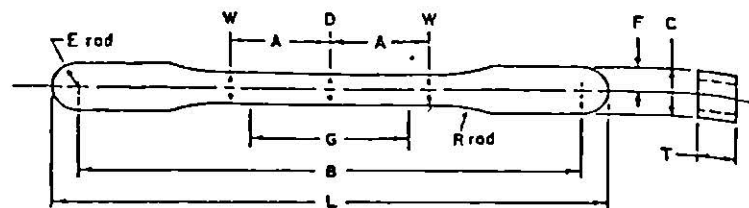

Pressing Area = 645 mm²

NOTE—Dimensions specified, except G and T, are those of the die.

Dimensions, mm

G—Gage length	25.40 ± 0.8
D—Width at center	5.72 ± 0.03
W—Width at end of reduced section	5.97 ± 0.03
T—Compact to this thickness	3.56 to 6.35
R—Radius of fillet	25.4
A—Half-length of reduced section	15.88
B—Grip length	80.95 ± 0.03
L—Overall length	89.64 ± 0.03
C—Width of gnp section	8.71 ± 0.03
F—Half-width of gnp section	4.34 ± 0.03
E—End radius	4.34 ± 0.03

FIG. 19 Standard Flat Unmachined Tension Test Specimen for Powder Metallurgy (P/M) Products

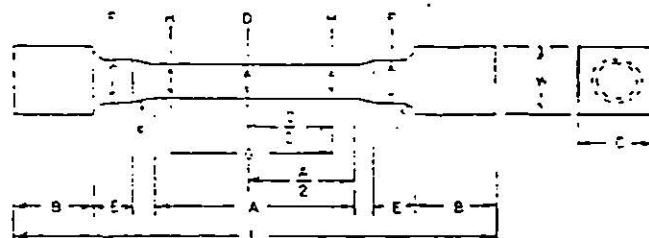

Approximate Pressing Area of Unmachined Compact = 752 mm²
Machining Recommendations

1. Rough machine reduced section to 6.35 mm diameter
2. Finish turn 4.75/4.85 mm diameter with radii and taper
3. Polish with 00 emery cloth
4. Lap with crocus cloth

Dimensions, mm

G—Gage length	25.40 ± 0.8
D—Diameter at center of reduced section	4.75 ± 0.03
H—Diameter at ends of gage length	4.85 ± 0.03
R—Radius of fillet	6.35 ± 0.13
A—Length of reduced section	47.63 ± 0.13
L—Overall length (die cavity length)	75, nominal
B—Length of end section	7.88 ± 0.13
C—Compact to this end thickness	10.03 ± 0.13
W—Die cavity width	10.03 ± 0.08
E—Length of shoulder	6.35 ± 0.13
F—Diameter of shoulder	7.88 ± 0.03
J—End fillet radius	1.27 ± 0.13

NOTE 1—The gage length and fillets of the specimen shall be as shown. The ends as shown are designed to provide a practical minimum pressing area. Other end designs are acceptable, and in some cases are required for high-strength sintered materials.

NOTE 2—It is recommended that the test specimen be gripped with a split collet and supported under the shoulders. The radius of the collet support circular edge is to be not less than the end fillet radius of the test specimen.

NOTE 3—Diameters D and H are to be concentric within 0.03 mm total indicator runout (T.I.R.), and free of scratches and tool marks.

FIG. 20 Standard Round Machined Tension Test Specimen for Powder Metallurgy (P/M) Products

APPENDIX

(Nonmandatory Information)

X1. FACTORS AFFECTING TENSION TEST RESULTS

X1.1 The precision and bias of tension test strength and ductility measurements depend on strict adherence to the stated test procedure and are influenced by instrumental and material factors, specimen preparation, and measurement/testing errors.

X1.2 The consistency of agreement for repeated tests of the same material is dependent on the homogeneity of the material, and the repeatability of specimen preparation, test conditions, and measurements of the tension test parameters.

X1.3 Instrumental factors that can affect test results include: the stiffness, damping capacity, natural frequency, and mass of the tensile test machine, the accuracy of loading and the use of loads within the verified range for the machine, speed of loading, alignment of the test specimen with the applied load, parallelness of the grips, grip pressure, nature of the load control used, appropriateness and calibration of extensometers used, and so forth.

X1.4 Material factors that can affect test results include: representativeness and homogeneity of the test material, sampling scheme, and specimen preparation (surface finish, dimensional accuracy, fillets at the ends of the gage length, taper in the gage length, bent specimens, thread quality, and so forth).

X1.4.1 Some materials are very sensitive to the quality of the surface finish of the test specimen (see Note 11) and must be ground to a fine finish, or polished to obtain correct results.

X1.4.2 Test results for specimens with as-cast, as-rolled, as-forged, or other non-machined surface conditions can be affected by the nature of the surface (see Note 12).

X1.4.3 Test specimens taken from appendages to the part or component, such as prolongs or risers, or from separately produced castings (for example, keel blocks) may produce test results that are not representative of the part or component.

X1.4.4 Test specimen size can influence test results. For cylindrical specimens, changing the test specimen size generally has a negligible effect on the yield and tensile strength but may influence the yield point, if one is present, and will influence the elongation and reduction of area values. In general, increasing the specimen size reduces the % elongation and % reduction in area, although some studies have shown no effect, or the opposite effect. For rectangular tensile test specimens, increasing the width or thickness generally increases the % elongation and decreases the % reduction in area.

X1.4.5 Use of a taper in the gage length, up to the allowed 1 % limit, can result in lower elongation values. Reductions of as much as 15 % have been reported for a 1 % taper.

X1.4.6 Some materials are highly strain-rate sensitive. Changes in the strain rate can affect the yield strength and elongation values, especially for strain-rate sensitive mate-

rials. In general, the yield strength and elongation will increase as the strain rate increases.

X1.4.7 Brittle materials require careful specimen preparation, high quality surface finishes, large fillets at the ends of the gage length, oversize threaded grip sections, and cannot tolerate punch or scribe marks as gage length indicators.

X1.4.8 Flattening of tubular products to permit testing does alter the material properties, generally nonuniformity, in the flattened region which may affect test results.

X1.5 Measurement errors that can affect test results include: verification of the test force, extensometers, micrometers, dividers, and other measurement devices, alignment and zeroing of chart recording devices, and so forth.

X1.5.1 Measurement of the dimensions of as-cast, as-rolled, as-forged, and other test specimens with non-machined surfaces may be imprecise due to the irregularity of the surface flatness.

X1.5.2 Materials with anisotropic flow characteristics may exhibit non-circular cross sections after fracture and measurement precision may be affected, as a result (see Note 24).

X1.5.3 The corners of rectangular test specimens are subject to constraint during deformation and the originally flat surfaces may be parabolic in shape after testing which will affect the precision of final cross-sectional area measurements (see Note 25).

X1.5.4 If any portion of the fracture occurs outside of the middle of the gage length, or in a punch or scribe mark within the gage length, the elongation and reduction of area values may not be representative of the material. Wire specimens that break at or within the grips may not produce test results representative of the material.

X1.5.5 Use of specimens with shouldered ends ("button-head" tensiles) will produce lower 0.02 % offset yield strength values than threaded specimens.

X1.6 Because standard reference materials with certified tensile property values are not available, it is not possible to rigorously define the bias of tension tests. However, by the use of carefully designed and controlled interlaboratory studies, a reasonable definition of the precision of tension test results can be obtained.

X1.6.1 An interlaboratory test program⁸ was conducted where six specimens each, of six different materials were prepared and tested by each of six different laboratories. Tables 2.1 to 2.6 present the precision statistics, as defined in Practice E 691, for: tensile strength, 0.02 % yield strength, 0.2 % yield strength, % elongation in 5D, and % reduction in area. In each table, the first column lists the six materials tested, the second column lists the average of the average results obtained by the laboratories, the third and fifth columns list the repeatability and reproducibility standard deviations, the fourth and sixth columns list the coefficient of variation for these standard deviations, and the seventh

and eighth columns list the 95 % repeatability and reproducibility limits.

X1.6.2 The averages (below columns four and six in each table) of the coefficients of variation permit a relative comparison of the repeatability (within-laboratory precision) and reproducibility (between-laboratory precision) of the tension test parameters. This shows that the ductility measurements exhibit less repeatability and reproducibility than the strength measurements. The overall ranking from the least to the most repeatable and reproducible is: % elongation in 4D, % reduction in area, 0.02 % offset yield strength, 0.2 % offset yield strength, and tensile strength. Note that the

rankings are in the same order for the repeatability and reproducibility average coefficients of variation and that the reproducibility (between-laboratory precision) is poorer than the repeatability (within-laboratory precision), as would be expected.

X1.6.3 No comments about bias can be made for the interlaboratory study due to the lack of certified test results for these specimens. However, examination of the test results showed that one laboratory consistently exhibited higher than average strength values and lower than average ductility values for most of the specimens. One other laboratory had consistently lower than average tensile strength results for all specimens.

TABLE X1.1 Precision Statistics—Tensile Strength, ksi

Material	X	s_r	$s_r/X, \%$	s_R	$s_R/X, \%$	r	R
EC-H19	25.66	0.63	2.45	0.63	2.45	1.76	1.76
2024-T351	71.26	0.88	1.24	0.96	1.34	2.47	2.68
ASTM A105	86.57	0.60	0.70	1.27	1.46	1.68	3.55
AISI 316	100.75	0.39	0.39	1.21	1.20	1.09	3.39
Inconel 600	99.48	0.42	0.43	0.72	0.72	1.19	2.02
SAE 51410	181.73	0.46	0.25	1.14	0.63	1.29	3.20
Averages:			0.91		1.30		

NOTE: X is the average of the cell averages, that is, the grand mean for the test parameter.
 s_r is the repeatability standard deviation (within-laboratory precision).
 s_r/X is the coefficient of variation in %.
 s_R is the reproducibility standard deviation (between-laboratory precision).
 s_R/X is the coefficient of variation, %.
r is the 95 % repeatability limits.
R is the 95 % reproducibility limits.

TABLE X1.2 Precision Statistics—0.02 % Yield Strength, ksi

Material	X	s_r	$s_r/X, \%$	s_R	$s_R/X, \%$	r	R
EC-H19	16.17	0.65	3.99	1.19	7.36	1.81	3.33
2024-T351	51.38	0.84	1.64	0.89	1.73	2.36	2.49
ASTM A105	59.66	1.20	2.02	1.89	3.18	3.37	5.31
AISI 316	48.62	2.39	4.91	4.61	9.49	6.68	12.91
Inconel 600	38.74	0.46	1.18	0.76	1.96	1.28	2.13
SAE 15410	104.90	2.40	2.29	3.17	3.02	6.73	8.88
Averages:			2.67		4.46		

TABLE X1.3 Precision Statistics—0.2 % Yield Strength, ksi

Material	X	s_r	$s_r/X, \%$	s_R	$s_R/X, \%$	r	R
EC-H19	22.98	0.47	2.06	0.48	2.07	1.33	1.33
2024-T351	52.64	0.74	1.41	0.79	1.49	2.08	2.20
ASTM A105	58.36	0.83	1.42	1.44	2.47	2.31	4.03
AISI 316	69.63	0.94	1.35	2.83	4.07	2.63	7.93
Inconel 600	38.91	0.36	0.93	0.85	2.18	1.01	2.37
SAE 51410	140.33	1.29	0.92	2.30	1.64	3.60	6.45
Averages:			1.35		2.32		

TABLE X1.4 Precision Statistics—% Elongation in 5D

Material	X	s_v	$s_v/X, \%$	s_R	$s_R/X, \%$	r	R
EC-H19	14.61	0.59	4.03	0.66	4.52	1.65	1.85
2024-T351	18.04	0.64	3.57	1.72	9.53	1.81	4.81
ASTM A105	25.63	0.77	2.99	1.30	5.06	2.15	3.63
AISI 316	35.93	0.71	1.98	2.68	7.45	2.00	7.49
Inconel 600	41.58	0.67	1.61	1.60	3.86	1.88	4.49
SAE 51410	12.39	0.45	<u>3.61</u>	0.96	<u>7.75</u>	1.25	2.69
Averages:			2.97		6.36		

NOTE A1—Length of reduced section = 6D.

TABLE X1.5 Precision Statistics—% Reduction in Area

Material	X	s_v	$s_v/X, \%$	s_R	$s_R/X, \%$	r	R
EC-H19	79.14	1.94	2.45	2.02	2.56	5.44	5.67
2024-T351	30.31	2.07	6.82	3.58	11.80	5.79	10.01
ASTM A105	65.59	0.84	1.28	1.26	1.92	2.35	3.53
AISI 316	71.49	0.99	1.39	1.61	2.25	2.78	4.50
Inconel 600	59.34	0.67	1.14	0.70	1.18	1.89	1.97
SAE 51410	50.49	1.86	<u>3.69</u>	3.95	<u>7.81</u>	5.21	11.05
Averages:			2.80		4.59		

The American Society for Testing and Materials takes no position respecting the validity of any patent rights asserted in connection with any item mentioned in this standard. Users of this standard are expressly advised that determination of the validity of any such patent rights, and the risk of infringement of such rights, are entirely their own responsibility.

This standard is subject to revision at any time by the responsible technical committee and must be reviewed every five years and if not revised, either reapproved or withdrawn. Your comments are invited either for revision of this standard or for additional standards and should be addressed to ASTM Headquarters. Your comments will receive careful consideration at a meeting of the responsible technical committee, which you may attend. If you feel that your comments have not received a fair hearing you should make your views known to the ASTM Committee on Standards, 1916 Race St., Philadelphia, PA 19103.

APPENDIX

(Nonmandatory Information)

XI. FACTORS AFFECTING TENSION TEST RESULTS

X1.1 The precision and bias of tension test strength and ductility measurements depend on strict adherence to the stated test procedure and are influenced by instrumental and material factors, specimen preparation, and measurement/testing errors.

X1.2 The consistency of agreement for repeated tests of the same material is dependent on the homogeneity of the material, and the repeatability of specimen preparation, test conditions, and measurements of the tension test parameters.

X1.3 Instrumental factors that can affect test results include: the stiffness, damping capacity, natural frequency, and mass of the tensile test machine, the accuracy of loading and the use of loads within the verified range for the machine, speed of loading, alignment of the test specimen with the applied load, parallelness of the grips, grip pressure, nature of the load control used, appropriateness and calibration of extensometers used, and so forth.

X1.4 Material factors that can affect test results include: representativeness and homogeneity of the test material, sampling scheme, and specimen preparation (surface finish, dimensional accuracy, fillets at the ends of the gage length, taper in the gage length, bent specimens, thread quality, and so forth).

X1.4.1 Some materials are very sensitive to the quality of the surface finish of the test specimen (see Note 11) and must be ground to a fine finish, or polished to obtain correct results.

X1.4.2 Test results for specimens with as-cast, as-rolled, as-forged, or other non-machined surface conditions can be affected by the nature of the surface (see Note 12).

X1.4.3 Test specimens taken from appendages to the part or component, such as prolongs or risers, or from separately produced castings (for example, keel blocks) may produce test results that are not representative of the part or component.

X1.4.4 Test specimen size can influence test results. For cylindrical specimens, changing the test specimen size generally has a negligible effect on the yield and tensile strength but may influence the yield point, if one is present, and will influence the elongation and reduction of area values. In general, increasing the specimen size reduces the % elongation and % reduction in area, although some studies have shown no effect, or the opposite effect. For rectangular tensile test specimens, increasing the width or thickness generally increases the % elongation and decreases the % reduction in area.

X1.4.5 Use of a taper in the gage length, up to the allowed 1 % limit, can result in lower elongation values. Reductions of as much as 15 % have been reported for a 1 % taper.

X1.4.6 Some materials are highly strain-rate sensitive. Changes in the strain rate can affect the yield strength and elongation values, especially for strain-rate sensitive mate-

rials. In general, the yield strength and elongation will increase as the strain rate increases.

X1.4.7 Brittle materials require careful specimen preparation, high quality surface finishes, large fillets at the ends of the gage length, oversize threaded grip sections, and cannot tolerate punch or scribe marks as gage length indicators.

X1.4.8 Flattening of tubular products to permit testing does alter the material properties, generally nonuniformly, in the flattened region which may affect test results.

X1.5 Measurement errors that can affect test results include: verification of the test force, extensometers, micrometers, dividers, and other measurement devices, alignment and zeroing of chart recording devices, and so forth.

X1.5.1 Measurement of the dimensions of as-cast, as-rolled, as-forged, and other test specimens with non-machined surfaces may be imprecise due to the irregularity of the surface flatness.

X1.5.2 Materials with anisotropic flow characteristics may exhibit non-circular cross sections after fracture and measurement precision may be affected, as a result (see Note 24).

X1.5.3 The corners of rectangular test specimens are subject to constraint during deformation and the originally flat surfaces may be parabolic in shape after testing which will affect the precision of final cross-sectional area measurements (see Note 25).

X1.5.4 If any portion of the fracture occurs outside of the middle of the gage length, or in a punch or scribe mark within the gage length, the elongation and reduction of area values may not be representative of the material. Wire specimens that break at or within the grips may not produce test results representative of the material.

X1.5.5 Use of specimens with shouldered ends ("button-head" tensiles) will produce lower 0.02 % offset yield strength values than threaded specimens.

X1.6 Because standard reference materials with certified tensile property values are not available, it is not possible to rigorously define the bias of tension tests. However, by the use of carefully designed and controlled interlaboratory studies, a reasonable definition of the precision of tension test results can be obtained.

X1.6.1 An interlaboratory test program⁸ was conducted where six specimens each, of six different materials were prepared and tested by each of six different laboratories. Tables 2.1 to 2.6 present the precision statistics, as defined in Practice E 691, for: tensile strength, 0.02 % yield strength, 0.2 % yield strength, % elongation in 4D, and % reduction in area. In each table, the first column lists the six materials tested, the second column lists the average of the average results obtained by the laboratories, the third and fifth columns list the repeatability and reproducibility standard deviations, the fourth and sixth columns list the coefficients of variation for these standard deviations, and the seventh

and eighth columns list the 95 % repeatability and reproducibility limits.

X1.6.2 The averages (below columns four and six in each table) of the coefficients of variation permit a relative comparison of the repeatability (within-laboratory precision) and reproducibility (between-laboratory precision) of the tension test parameters. This shows that the ductility measurements exhibit less repeatability and reproducibility than the strength measurements. The overall ranking from the least to the most repeatable and reproducible is: % elongation in 5D, % reduction in area, 0.02 % offset yield strength, 0.2 % offset yield strength, and tensile strength. Note that the rankings are in the same order for the repeatability and

reproducibility average coefficients of variation and that the reproducibility (between-laboratory precision) is poorer than the repeatability (within-laboratory precision), as would be expected.

X1.6.3 No comments about bias can be made for the interlaboratory study due to the lack of certified test results for these specimens. However, examination of the test results showed that one laboratory consistently exhibited higher than average strength values and lower than average ductility values for most of the specimens. One other laboratory had consistently lower than average tensile strength results for all specimens.

TABLE X1.1 Precision Statistics—Tensile Strength, MPa

Material	X	s_r	$s_r/X, \%$	s_R	$s_R/X, \%$	r	R
EC-H19	177.5	0.63	2.45	0.63	2.45	1.76	1.76
2024-T351	492.9	0.88	1.24	0.96	1.34	2.47	2.68
ASTM A105	598.8	0.60	0.70	1.27	1.46	1.68	3.55
AISI 316	696.9	0.39	0.39	1.21	1.20	1.09	3.39
Inconel 600	688.1	0.42	0.43	0.72	0.72	1.19	2.02
SAE 51410	1257.0	0.46	0.25	1.14	0.63	1.29	3.20
Averages:			0.91		1.30		

NOTE: X is the average of the cell averages, that is, the grand mean for the test parameter.
 s_r is the repeatability standard deviation (within-laboratory precision).
 s_r/X is the coefficient of variation in %.
 s_R is the reproducibility standard deviation (between-laboratory precision).
 s_R/X is the coefficient of variation, %.
r is the 95 % repeatability limits.
R is the 95 % reproducibility limits.

TABLE X1.2 Precision Statistics—0.02 % Yield Strength, MPa

Material	X	s_r	$s_r/X, \%$	s_R	$s_R/X, \%$	r	R
EC-H19	111.8	0.65	3.99	1.19	7.36	1.91	3.33
2024-T351	355.4	0.84	1.64	0.89	1.73	2.36	2.49
ASTM A105	412.7	1.20	2.02	1.89	3.18	3.37	5.31
AISI 316	336.3	2.39	4.91	4.61	9.49	6.68	12.91
Inconel 600	268.0	0.46	1.18	0.76	1.95	1.28	2.13
SAE 51410	725.6	2.40	2.29	3.17	3.02	6.73	8.88
Averages:			2.67		4.46		

TABLE X1.3 Precision Statistics—0.2 % Yield Strength, MPa

Material	X	s_r	$s_r/X, \%$	s_R	$s_R/X, \%$	r	R
EC-H19	159.0	0.47	2.06	0.48	2.07	1.33	1.33
2024-T351	364.1	0.74	1.41	0.79	1.49	2.08	2.20
ASTM A105	403.7	0.83	1.42	1.44	2.47	2.31	4.03
AISI 316	481.6	0.94	1.35	2.83	4.07	2.63	7.93
Inconel 600	269.1	0.36	0.93	0.85	2.18	1.01	2.37
SAE 51410	970.7	1.29	0.92	2.30	1.64	3.60	6.45
Averages:			1.35		2.32		

TABLE X1.4 Precision Statistics—% Elongation in 4D

Material	X	s_x	$s_x/X, \%$	s_R	$s_R/X, \%$	r	R
EC-H19	17.45	0.64	3.69	0.92	5.30	1.80	2.59
2024-T351	19.75	0.59	2.99	1.58	8.00	1.65	4.43
ASTM A105	29.10	0.76	2.62	0.98	3.38	2.13	2.76
316	40.07	1.10	2.75	2.14	5.35	3.09	6.00
600	44.27	0.66	1.50	1.54	3.48	1.86	4.31
51410	14.48	0.48	3.29	0.99	6.83	1.34	2.77
Averages:			2.81		5.39		

Note A1—Length of reduced section = 6D.

TABLE X1.5 Precision Statistics—% Reduction in Area

Material	X	s_x	$s_x/X, \%$	s_R	$s_R/X, \%$	r	R
EC-H19	79.14	1.94	2.45	2.02	2.56	5.44	5.67
2024-T351	30.31	2.07	6.82	3.58	11.80	5.79	10.01
ASTM A105	65.59	0.84	1.28	1.26	1.92	2.35	3.53
316	71.49	0.99	1.39	1.61	2.25	2.78	4.50
600	59.34	0.67	1.14	0.70	1.18	1.89	1.97
51410	50.49	1.86	3.69	3.95	7.81	5.21	11.05
Averages:			2.80		4.59		

The American Society for Testing and Materials takes no position respecting the validity of any patent rights asserted in connection with any item mentioned in this standard. Users of this standard are expressly advised that determination of the validity of any such patent rights, and the risk of infringement of such rights, are entirely their own responsibility.

This standard is subject to revision at any time by the responsible technical committee and must be reviewed every five years and if not revised, either reapproved or withdrawn. Your comments are invited either for revision of this standard or for additional standards and should be addressed to ASTM Headquarters. Your comments will receive careful consideration at a meeting of the responsible technical committee, which you may attend if you feel that your comments have not received a fair hearing. You should make your views known to the ASTM Committee on Standards, 1916 Race St., Philadelphia, PA 19103.

La máxima resistencia a la tensión y el módulo de elasticidad para cada polímero son:

Polímero	Resistencia a la tensión (psi)	Módulo de elasticidad (ksi)	Estructura
Poliétileno BD	3000	40	Altamente ramificada, amorfa con meros simétricos
Poliétileno AD	5500	180	Amorfa con meros simétricos pero escasa ramificación
Polipropileno	6000	220	Amorfa con pequeños grupos laterales de metilo
Poliestireno	8000	450	Amorfa con grupos laterales de benceno
Cloruro de polivinilo	9000	600	Amorfa con grandes átomos de cloruro como grupos laterales

Se puede concluir que

- La ramificación, que reduce la densidad y la compactación de las cadenas, reduce las propiedades mecánicas del polietileno.
- Añadiendo átomos o grupos diferentes del hidrógeno a la cadena, se incrementan la resistencia y la rigidez. El grupo metilo en el polipropileno proporciona alguna mejoría, el anillo de benceno del estireno proporciona mejores propiedades y el átomo de cloruro en el cloruro de polivinilo proporciona una gran mejora en las propiedades mecánicas.

Polímero	Resistencia a la tensión (psi)	Elongación (%)	Módulo de elasticidad (ksi)
Termoplásticos por adición lineales	3000-12,000	5-800	40-600
Termoplásticos por condensación lineales	8000-17,000	10-300	250-600
Polímeros termoeestables	4000-15,000	0-6	500-1,600

Los polímeros por adición lineales tienen la menor resistencia y rigidez pero la mayor ductilidad. Los termoeestables tienen la mayor resistencia y rigidez pero son frágiles. La mayoría de los termoplásticos por condensación lineales tiene propiedades intermedias; su estructura molecular es normalmente más compleja que la de los polímeros por adición, pero no están ligados en forma cruzada como los termoeestables.

TABLA 12-5 Grupos funcionales para varios polímeros termoestables

Polímero	Estructura	Resistencia a la tensión (psi)	Elongación (%)	Módulo de elasticidad (ksi)	Densidad (g/cm ³)
Fenólicos		5,000-9,000	0-2	400-1300	1.27
Aminas	 Melamina	5,000-10,000	0-1	1000-1600	1.50
	 Urea				
Poliésteres		5,000-13,000	1-3	300-550	1.25
Epóxicos		4,000-15,000	0-6	400-500	1.25
Uretanos		5,000-10,000	3-6		1.30
Furanos		3,000-4,500		1530	1.75
Silicones		3,000-4,000	0	1200	1.55

TABLA 12-3 (continuación)

Polímero	Estructura	Resistencia a la tensión (psi)	Elongación (%)	Módulo de elasticidad (ksi)	Densidad (g/cm ³)
Poliimida		11,000-17,000	8-10	300	1.39

TABLA 12-3 Unidades repetitivas y propiedades para termoplásticos lípicos que tienen estructuras de cadena complicadas



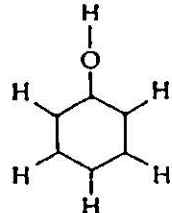
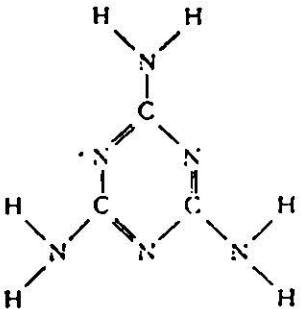
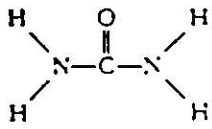
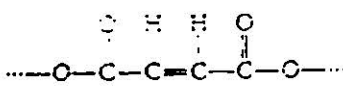
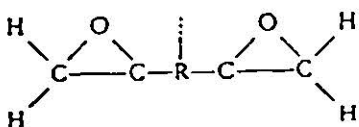
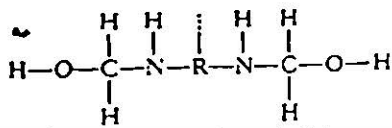
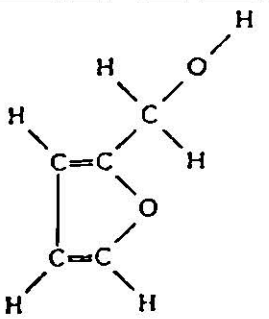
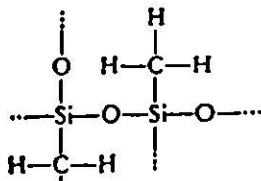

Polímero	Estructura	Resistencia a la tensión (psi)	Elongación (%)	Módulo de elasticidad (ksi)	Densidad (g/cm ³)
Poliéter (acetal)		9,500-12,000	25-75	520	1.42
Poliamida (nylon)		11,000-12,000	60-300	400-500	1.14
Poliéster (dacrón)		8,000-10,500	50-300	400-600	1.36
Policarbonato		9,000-11,000	110-130	300-400	1.2
Celulosa		2,000-8,000	3-50	200-250	1.30

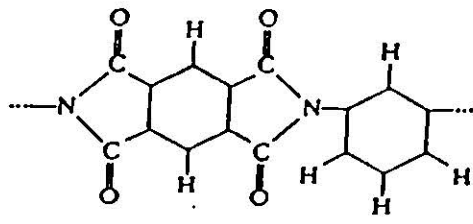
TABLA 12-2 Meros y las propiedades de algunos termoplásticos producidos mediante polimerización por adición

Polímero	Estructura	Resistencia a la tensión (psi)	Elongación (%)	Módulo de elasticidad (ksi)	Densidad (g/cm ³)
Poliétileno baja densidad (BD) alta densidad (AD)	$\begin{array}{c} \text{H} \quad \text{H} \\ \quad \\ \cdots \text{C} - \text{C} \cdots \\ \quad \\ \text{H} \quad \text{H} \end{array}$	600-3,000	50-800	15-40	0.92
	$\begin{array}{c} \text{H} \quad \text{H} \\ \quad \\ \cdots \text{C} - \text{C} \cdots \\ \quad \\ \text{H} \quad \text{H} \end{array}$	3,000-5,500	15-130	60-180	0.96
Cloruro de polivinilideno	$\begin{array}{c} \text{H} \quad \text{Cl} \\ \quad \\ \cdots \text{C} - \text{C} \cdots \\ \quad \\ \text{H} \quad \text{H} \end{array}$	5,000-9,000	2-100	300-600	1.40
Polipropileno	$\begin{array}{c} \text{H} \quad \text{H} \\ \quad \\ \cdots \text{C} - \text{C} \cdots \\ \quad \quad \\ \text{H} \quad \text{H} - \text{C} - \text{H} \\ \\ \text{H} \end{array}$	4,000-6,000	10-700	160-220	0.90
Poliestireno	$\begin{array}{c} \text{H} \quad \text{H} \\ \quad \\ \cdots \text{C} - \text{C} \cdots \\ \quad \\ \text{H} \quad \text{C}_6\text{H}_5 \end{array}$	3,200-5,000	1-50	350-450	1.05
Polimetilmetacrilato (Plexiglass acrílico)	$\begin{array}{c} \text{H} \quad \text{H} \\ \quad \\ \cdots \text{C} - \text{C} \cdots \\ \quad \\ \text{H} \quad \text{C} = \text{O} \\ \\ \text{O} \\ \\ \text{H} - \text{C} - \text{H} \\ \\ \text{H} \end{array}$	6,000-12,000	2-5	350-450	1.22
Cloruro de polivinilo	$\begin{array}{c} \text{H} \quad \text{Cl} \\ \quad \\ \cdots \text{C} - \text{C} \cdots \\ \quad \\ \text{H} \quad \text{Cl} \end{array}$	3,500-5,000	160-240	50-80	1.15
Policlorotrifluoroetileno	$\begin{array}{c} \text{F} \quad \text{Cl} \\ \quad \\ \cdots \text{C} - \text{C} \cdots \\ \quad \\ \text{F} \quad \text{F} \end{array}$	4,500-6,000	80-250	150-300	2.15
Politetrafluoroetileno (teflón)	$\begin{array}{c} \text{F} \quad \text{F} \\ \quad \\ \cdots \text{C} - \text{C} \cdots \\ \quad \\ \text{F} \quad \text{F} \end{array}$	2,000-7,000	100-400	60-80	2.17

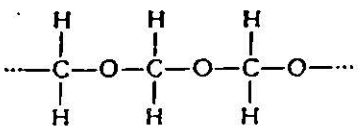
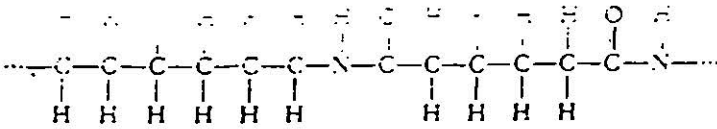
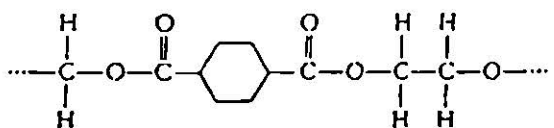
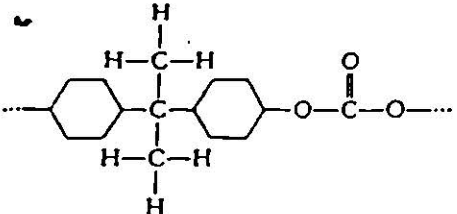
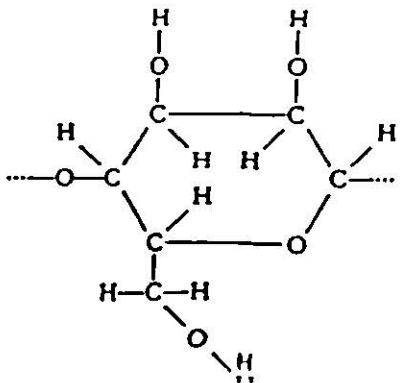
PROPIEDAD DE LA FIBRA	FIBRAS NATURALES			FIBRAS ARTIFICIALES (ORGANICAS)			FIBRAS ARTIFICIALES INORGANICAS
	VEGETALES	ANIMALES		CONDENSACION		ADICION	
NOMBRE DE FIBRA	ALGODON	LANA	SEDA	NILOH	TERYLENE	POLIETILENO	VIDRIO
UNIDAD MONOME	CELULOSA	QUERATINA	FIBROINA Y SERICINA	AMIDA	ESTER	ETILENO	SiO ₂
RESISTENCIA:							
a) ALCALIS	ALTA	BAJA	BAJA	ALTA	REGULAR	BUENA	MALA
b) SOLVENTES ORGANICOS	ALTA	ALTA	ALTA	REGULAR	REGULAR	REGULAR	BUENA
c) ACIDOS	BAJA	BAJA	BAJA	BAJA	REGULAR	BUENA	BUENA
d) HONGOS	REGULAR	REGULAR	BAJA	ALTA	ALTA	ALTA	ALTA
e) INSECTOS	BAJA	BAJA	BAJA	ALTA	ALTA	ALTA	ALTA
DENSIDAD	1.54 g/cm ³	1.52 g/cm ³	1.22	1.14 g/cm ³	1.13	0.9-0.92 g/cm ³	2.5-2.7 g/cm ³
ABSORBENCIA H ₂ O	7-8.5%	16%	30%	4%	CASI NULO	NULO	
LONGITUD DE 1 FIBRA	12-55mm	35-35mm	MÁS DE 1000 mm POR CAVILLO	25-125mm			
MAXIMO PESO QUE SOPORTA 1 HILO	4.2 kg/cm ²	1.4 kg/cm ²	3.70 kg/cm ²	50-70 kg/cm ²			
RESISTENCIA A LA TRACCION (kg/cm ²)	4.200	1.400	4.90	5.0	4.900	.400	21.00
TEMPERATURA MAX. DE TRABAJO OC	100	100	200	210	220	70	350
DIAMETRO	20	16-50	8-15				

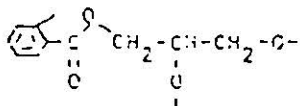
EJEMPLO	MONOMEROS	POLIMERO (UNIDAD MONOMERICA)	USOS
POLIAMIDAS (nylon)	$\text{HO}-\overset{\text{O}}{\parallel}{\text{C}}-(\text{CH}_2)_4-\overset{\text{O}}{\parallel}{\text{C}}-\text{OH}$ ACIDO ADIPICO $\text{H}_2\text{N}-(\text{CH}_2)_6-\text{NH}_2$ HEXAMETILEN DIAMINA	$-\overset{\text{O}}{\parallel}{\text{C}}-(\text{CH}_2)_4-\overset{\text{O}}{\parallel}{\text{C}}-\text{NH}-(\text{CH}_2)_6-\text{NH}-$	Fibras y objetos moldeados.
POLIESTERES (dacrón, mylar, fortrel)	$\text{HO}-\overset{\text{O}}{\parallel}{\text{C}}-\text{C}_6\text{H}_4-\overset{\text{O}}{\parallel}{\text{C}}-\text{OH}$ ACIDO TEREFTALICO $\text{HO}-(\text{CH}_2)_2-\text{OH}$ SI N=2 ETILENGLICOL	$-\overset{\text{O}}{\parallel}{\text{C}}-\text{C}_6\text{H}_4-\overset{\text{O}}{\parallel}{\text{C}}-\text{O}-(\text{CH}_2)_2-\text{O}-$	Polímeros lineales, fibras, cintas magnéticas.
POLIESTERES	 ANHIDRIDO FTALICO $\text{HO}-\text{CH}_2-\text{CH}(\text{OH})-\text{CH}_2-\text{OH}$ GLICERINA		Pinturas, polímeros de cadena cruzada.
POLIESTERES	$\text{HO}-\overset{\text{O}}{\parallel}{\text{C}}-\text{CH}=\text{CH}-\overset{\text{O}}{\parallel}{\text{C}}-\text{OH}$ $\text{HO}-(\text{CH}_2)_2-\text{OH}$ SI N=2 ETILENGLICOL	$-\overset{\text{O}}{\parallel}{\text{C}}-\text{CH}=\text{CH}-\overset{\text{O}}{\parallel}{\text{C}}-\text{O}-(\text{CH}_2)_2-\text{O}-$	Cadena cruzada con estiramiento y peróxido: resina-fibra de vidrio.
RESINA FENOL-FORMALDEHIDICO (Bakelita)	 FENOL $\text{CH}_2=\text{O}$ FORMALDEHIDICO		Resinas, laminados, barnices.
ACEGATO DE CELULOSA	 CELULOSA $\text{CH}_3\text{C}(=\text{O})\text{OH}$ ACIDO ACETICO		Película fotográfica.

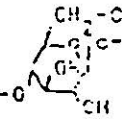
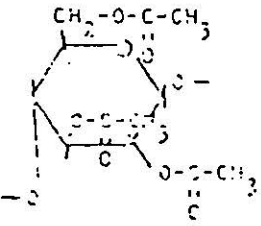
POLIMEROS POR CONDENSACION.

EJEMPLO	MONOMEROS	(UNIDAD MONOMERICAS) POLIMERO	USOS
POLIETILENO	$\text{CH}_2=\text{CH}_2$ ETILENO	$-\text{CH}_2-\text{CH}_2-$ $[-\text{CH}_2-\text{CH}_2-]_n$	El más común e importante polímero. Bolsas, aislamiento y botellas moldeadas.
POLIPROPILENO	$\begin{array}{c} \text{CH}_2=\text{CH} \\ \\ \text{CH}_3 \end{array}$ PROPILENO	$-\text{CH}_2-\text{CH}-$ $ $ CH_3	Fibras para alfombras interiores y exteriores.
POLIESTIRENO	$\begin{array}{c} \text{CH}_2=\text{CH} \\ \\ \text{C}_6\text{H}_5 \end{array}$ ESTIRENO	$-\text{CH}_2-\text{CH}-$ $ $ C_6H_5	Moldeo de objetos para uso doméstico e industrial.
POLICLORURO DE VINILO PVC	$\begin{array}{c} \text{CH}_2=\text{CH} \\ \\ \text{Cl} \end{array}$ CLORURO DE VINILO	$-\text{CH}_2-\text{CH}-$ $ $ Cl	Recubrimiento de pisos, acetatos de discos, tubos para agua, envases y botellas transparentes.
POLITETRAFLUORURO DE ETILENO (TEFLON PTFE)	$\begin{array}{c} \text{F} & & \text{F} \\ & \diagdown & / \\ & \text{C} = \text{C} \\ & / & \diagdown \\ \text{F} & & \text{F} \end{array}$ TETRAFLURO ETILENO	$-\text{CF}_2-\text{CF}_2-$	Caras inastillables, resistente a películas químicas.
POLIMETACRILATO DE METILO	$\begin{array}{c} \text{C}=\text{C}-\text{O}-\text{CH}_3 \\ \\ \text{CH}_2 \\ \\ \text{CH}_3 \end{array}$ METIL-METACRILATO	$-\text{CH}_2-\text{C}-\text{O}-\text{CH}_3$ $ $ CH_3	Vidrio irrompible y pinturas latex.
POLIACRILATO NITRICO Goma nitrilica	$\begin{array}{c} \text{C}=\text{C} \\ \\ \text{CN} \end{array}$ ACRILATO NITRICO	$-\text{CH}_2-\text{C}-$ $ $ CN	Resistente a aceites y gasolina.
POLI-ACETATO DE VINILO	$\begin{array}{c} \text{CH}_2=\text{C} \\ \\ \text{C}-\text{O}-\text{CH}_3 \\ \\ \text{O} \end{array}$ ACETATO DE VINILO	$-\text{CH}_2-\text{C}-$ $ $ $\text{C}-\text{O}-\text{CH}_3$ $ $ O	Adhesivos, pinturas latex, capas textiles y gomas de mascar.
HULE NATURAL	$\begin{array}{c} \text{CH}_3 \\ \\ \text{CH}_2=\text{C}-\text{CH}=\text{CH}_2 \end{array}$ CIS-1,4-ISOPRENO	$-\text{CH}_2-\text{C}-\text{CH}=\text{CH}_2-$ $ $ CH_3	El polímero con cadenas cruzadas de sulfuro por vulcanización.
POLICLOROPRENO (NEOPRENO)	$\begin{array}{c} \text{Cl} \\ \\ \text{CH}_2=\text{C}-\text{CH}=\text{CH}_2 \end{array}$ CLOROPRENO	$-\text{CH}_2-\text{C}-\text{CH}=\text{CH}_2-$ $ $ Cl	Con cadenas cruzadas de Zn O es resistente a aceites y gasolina.
ESTIRENO-BUTADIENO (SBR)	$\begin{array}{c} \text{CH} \\ \\ \text{C}_6\text{H}_5 \end{array} = \text{CH}_2$ ESTIRENO $\text{CH}_2 = \text{CH} - \text{CH} = \text{CH}_2$ BUTADIENO	$-\text{CH}_2-\text{CH}-\text{CH}_2-\text{CH}=\text{CH}-\text{CH}_2-$ $ $ C_6H_5 GOMA S	Con cadenas cruzadas de peróxido; es el más común hule, usado para llantas, contiene 75% butadieno.

POLIMEROS POR ADICION.

TABLA B.3. PROPIEDADES MECANICAS DE LAS ALEACIONES LIGERAS NO FERROSAS*

Aleación	Composición aproximada, porcentaje	Resistencia a la cedencia por tensión,† lb/plg²	Resistencia a la tensión, lb/plg²	Módulo de elasticidad en tensión, 10⁶ lb/plg²	Porcentaje de elongación en 2 plg	Resistencia al corte, lb/plg²	Número de dureza de Rockwell	Límite de fatiga para flexiones revertidas, lb/plg²	Peso, lb/plg³
Aleación de aluminio 2024: Temple O Temple T36	Aluminio 93; cobre 4.5; magnesio 1.5; manganeso 0.6	11 000	27 000	10.6	20	18 000	H90	13 000	0.100
		37 000	72 000	10.6	13	42 000	B80	18 000	0.100
Aleación de aluminio 2014: Temple O Temple T6	Aluminio 93; cobre 4.4; silice 0.8; manganeso 0.8; magnesio 0.4	14 000	27 000	10.6	18	15 000	H92	13 000	0.102
		50 000	70 000	10.6	13	42 000	B33	18 000	0.102
Aleación de aluminio 5052: Temple O Temple H38	Aluminio 97; magnesio 2.5; cromo 0.25	13 000	28 000	10.0	30	18 000	H82	16 000	0.096
		37 000	42 000	10.0	8	24 000	E83	20 000	0.096
Aleación de aluminio 5456: Temple O Temple H321	Aluminio 94; magnesio 5.0; manganeso 0.7; cobre 0.15; cromo 0.15	23 000	45 000	24	28 000	0.092
		37 000	51 000	16	30 000	0.092
Aleación de aluminio 7075: Temple O Temple T6	Aleación 90; cinc 5.5; cobre 1.5; magnesio 2.5; cromo 0.3	15 000	33 000	17	22 000	E63		
		73 000	83 000	11	43 000	H90	23 000	
Aleación de magnesio AM100A: Fundición, condición F Fundición, condición T61	Magnesio 90; aluminio 10; manganeso 0.1	12 000	22 000	6.5	2	18 000	E71	10 000	0.066
		22 000	40 000	6.5	1	21 000	E80	10 000	0.066
Aleación de magnesio AZ63A: Fundición, condición F Fundición, condición T6	Magnesio 91; aluminio 6; cinc 3; manganeso 0.2	14 000	29 000	6.3	4	16 000	E39	11 000	0.066
		19 000	40 000	6.5	3	20 000	E83	11 000	0.066

Propiedades elásticas de materiales representativos, a temperatura ordinaria

Material	Módulo Young E, 10¹⁰ N/m²†	Relación de Poisson, ν	Rigidez específica Eρ, 10⁶ N · m/kg‡
Grafito	100		5 000
Cristales de Al₂O₃ (zafiro)	[1010]		587
	[1120]		310
	[0001]		120
Boro	45	0.21	190
Carburo sinterizado (WC)	65	0.20	46
Vitreo-cerámico	10	0.25	39
Vidrio de sílice	8	0.24	32
Aleaciones de aluminio	7	0.53	26
Acero	20	0.28	25
Tungsteno	41	0.29	21
Madera (típica):			
longitudinal‡	1	~0.04	16
radial	0.07	~0.3	1
tangencial	0.06	~0.5	1
Aleaciones de cobre	12	0.35	13
Nilón (nylon)	0.3	0.48	3
Polietileno	0.04	0.3	0.4

† Para convertir N/m² en kgf/cm², multiplíquese por 1.020 × 10⁻⁵ y en lb/pulg², por 2.450 × 10⁻⁴.

‡ Para convertir N · m/kg en kgf · m/kg, multiplíquese por 9.80 y en lb · pulg/lb_{masa}, por 4.01.

TABLA 6-3 Relación entre el módulo de elasticidad y la temperatura de fusión de los metales

Metal	Temperatura de fusión (°C)	Módulo de elasticidad (psi)
Pb	327	2.0 × 10⁵
Mg	650	6.5 × 10⁵
Al	660	10.0 × 10⁵
Ag	962	10.3 × 10⁵
Au	1064	11.3 × 10⁵
Cu	1085	18.1 × 10⁵
Ni	1453	29.9 × 10⁵
Fe	1538	30.0 × 10⁵
Mn	2610	43.4 × 10⁵
W	3410	58.5 × 10⁵

TABLA 13-2 Propiedades de algunos materiales reforzados con fibras

Material	Densidad (g/cm ³)	Resistencia a la tensión (ksi)	Módulo de elasticidad (× 10 ⁶ psi)	Temperatura de fusión (°C)	Módulo específico (× 10 ⁶ pl/g)	Resistencia específica (× 10 ⁶ pl/g)
Vidrio E	2.55	500	10.5	<1725	11.4	5.6
Vidrio S	2.50	650	12.6	<1725	14.0	7.2
SiO ₂	2.19	850	10.5	1728	15.5	10.8
Al ₂ O ₃	3.15	500	23.0	2015	21.9	2.6
ZrO ₂	4.84	500	50	2677	28.6	1.7
Grafito HS (alta resistencia)	1.50	400	40	3700	74.2	7.4
Grafito HM (alto módulo)	1.50	270	77	3700	149	5.0
BN	1.90	200	13	2730	18.8	2.9
Bom	2.36	500	55	2050	64.7	4.7
B ₄ C	2.36	330	70	2450	82.4	3.9
SiC	4.09	500	70	2700	47.3	2.3
TiB ₂	4.48	13	74	2980	45.3	0.1
Be	1.85	135	44	1277	77.3	2.3
W	19.4	580	59	3410	3.5	0.3
Mo	10.2	320	52	2610	14.1	0.9
Kevlar	1.44	525	18		54.7	10.1
Whiskers						
de Al ₂ O ₃	3.96	3000	62	1982	45.4	21.0
de BeO	2.85	1900	50	2550	48.5	18.5
de B ₄ C	2.32	2000	70	2450	76.9	22.1
de SiC	3.18	3000	70	2700	60.8	26.2
de Si ₃ N ₄	3.18	2000	55		47.8	17.5
de grafito	1.66	3000	102	3700	170	50.2
de Cr	7.2	1290	35	1890	13.4	4.9
de Cu	8.92	427	18	1095	5.6	1.5

Adaptado de E. J. Reuter, "Mechanical Properties of Fiber Reinforced Plastics", *Composite Engineering Laminates*, ed. G. H. Durr, The M.I.T. Press, 1969

TABLA D.1. RESISTENCIA DE LA MADERA SECADA A LA INTEMPERIE 93

Nombre comercial	Peso específico	Peso, lb/plg ³	Flexión estática *			Flexión por impacto, altura de caída que causa la falla, golpe de 50 lb. plg	Compresión paralela al grano ²		Compresión perpendicular del grano, esfuerzo en el límite proporcional, lb/plg ² .	Corte parale al grano, resistencia máxima, lb/plg ²
			Esfuerzo en las fibras en el límite proporcional, lb/plg ²	Módulo de			Esfuerzo en el límite proporcional, lb/plg ²	Resistencia máxima, lb/plg ²		
				Ruptura, lb/plg ²	Elasticidad, 1 000 lb/plg ²					
Fresno de Oregón.....	0.55	34	7 000	1 360	33	4 100	6 040	1 540	1 790	
Cedar, rojo occidental....	0.33	21	7 700	1 120	17	4 300	5 020	610	860	
Douglas fir (de la costa).	0.48	30	11 700	1 920	30	6 450	7 420	910	1 140	
Hemlock, occidental.....	0.42	26	10 100	1 490	26	5 340	6 210	680	1 170	
Jicore, verdadero.....	0.73	46	10 500	2 180	75	...	5 970	2 310	2 140	
Locust, negro.....	0.69	43	12 800	2 050	57	6 500	10 180	2 260	2 480	
Maple, rojo.....	0.54	34	8 700	1 640	32	4 650	6 540	1 240	1 850	
Roble, blanco.....	0.67	42	7 900	1 620	39	4 350	7 040	1 410	1 890	
Pino de ponderosa.....	0.40	25	6 300	1 200	17	4 000	5 270	740	1 160	
Pino de hoja larga.....	0.58	36	9 300	1 990	34	6 150	8 440	1 190	1 500	
Madera roja (virgen)....	0.40	25	6 900	1 340	19	4 560	6 150	860	940	
Abeto de Sitka.....	0.40	25	6 700	1 570	25	4 780	5 610	710	1 150	

* Wood Handbook (Manual de la Madera), Forest Products Laboratory (Laboratorio de Productos Forestales), U.S. Department of Agriculture, Departamento de Agricultura de los Estados Unidos, 1953.

¹ Todas las probetas son de madera limpia de grano recto con un contenido de humedad de 12%.

² Probeta de 2 x 2 x 50 plg sobre claro de 28 plg.

³ Probeta de 2 x 2 x 9 plg, 6 plg longitud.

⁴ Probeta de 2 x 2 x 6 plg, 4 plg bajo carga.

⁵ Resistencia al corte transversal al grano, aproximadamente 5 veces el equivalente de la paralela al grano.

PARTE 2 — CERÁMICAS (Tomados de medios numerosos)

Material	Gravedad específica	Conductividad térmica en cal·cm °C·cm ² ·seg a 20°C*	Expansión térmica en plg/plg/°C a 20°C†	Resistividad eléctrica en ohm·cm a 20°C‡	Módulo de elasticidad promedio, lb/plg ² a 20°C
Al ₂ O ₃	3.8	0.07	5 × 10 ⁻⁶	—	50 × 10 ⁶
Tabique					
Edificio	2.3(±)	0.0015	5 × 10 ⁻⁶	—	—
Arcilla fuego	2.1	0.002	2.5 × 10 ⁻⁶	1.4 × 10 ⁸	—
Grafito	1.5	—	3 × 10 ⁻⁶	—	—
Pavimento	2.5	—	2 × 10 ⁻⁶	—	—
Sílice	1.75	0.002	—	1.2 × 10 ⁸	—
Concreto	2.4(±)	0.0025	7 × 10 ⁻⁶	—	2 × 10 ⁶
Vidrio					
Plancha	2.5	0.0018	5 × 10 ⁻⁶	10 ¹⁴	—
Borosilicato	2.4	0.0025	1.5 × 10 ⁻⁶	—	10 × 10 ⁶
Sílice	2.2	0.003	0.3 × 10 ⁻⁶	10 ²⁰	10 × 10 ⁶
Vycor	2.2	0.003	0.35 × 10 ⁻⁶	—	—
Lana	0.05	0.0006	—	—	—
Grafito (bulk)	1.9	—	3 × 10 ⁻⁶	10 ⁻³	1 × 10 ⁶
MgO	3.6	—	5 × 10 ⁻⁶	10 ⁵ (2000°F)	30 × 10 ⁶
Cuarzo (SiO ₂)	2.65	0.03	7 × 10 ⁻⁶	—	45 × 10 ⁶
SiC	3.17	0.029	2.5 × 10 ⁻⁶	2.5 (2000°F)	—
TiC	4.5	0.07	4 × 10 ⁻⁶	50 × 10 ⁻⁶	50 × 10 ⁶

PARTE 3 — MATERIALES ORGÁNICOS (Tomados de numerosos medios).

Material	Gravedad específica	Conductividad térmica en cal·cm °C·cm ² ·seg a 20°C*	Expansión térmica en plg/plg/°C a 20°C†	Resistividad eléctrica en ohm·cm a 20°C‡	Módulo de elasticidad promedio, lb/plg ² a 20°C
Melamina-formaldehido	1.5	0.0007	15 × 10 ⁻⁶	10 ¹³	1.3 × 10 ⁶
Fenol-formaldehido	1.3	0.0004	40 × 10 ⁻⁶	10 ¹²	0.5 × 10 ⁶
Urea-formaldehido	1.5	0.0007	15 × 10 ⁻⁶	10 ¹²	1.5 × 10 ⁶
Hules (sintéticos)	1.5	0.0003	—	—	500-10,000
Hule (vulcanizado)	1.2	0.0003	45 × 10 ⁻⁶	10 ¹⁴	0.5 × 10 ⁶
Polietileno	0.9	0.0005	100 × 10 ⁻⁶	10 ¹³	—
Poliestireno	1.05	0.0002	35 × 10 ⁻⁶	10 ¹³	0.4 × 10 ⁶
Cloruro de polivinilideno	1.7	0.0003	105 × 10 ⁻⁶	10 ¹³	0.05 × 10 ⁶
Poltetrafluoroetileno	2.2	0.0003	55 × 10 ⁻⁶	10 ¹⁶	—
Metacrilato de polimetilo	1.2	0.0005	50 × 10 ⁻⁶	10 ¹⁶	0.5 × 10 ⁶
Nylon	1.15	0.0006	55 × 10 ⁻⁶	10 ¹⁴	0.4 × 10 ⁶

* Multiplicar por 0.806 para tener Btu·plg/°F·pie²·seg. † Multiplicar por 1.8 para tener cm/cm/°C. ‡ Dividir entre 2.54 para tener ohm·plg.

TABLA 10-8 Designaciones de grado de endurecimiento para aleaciones de cobre

Hxx—trabajada en frío. (xx indica el grado de trabajo en frío.)

	Reducción porcentual en espesor o diámetro
H01 ½ dura	10.9
H02 ¼ dura	20.7
H03 ⅓ dura	29.4
H04 dura	37.1
H06 extradura	50.1
H08 de resorte duro	60.5
H10 de resorte extra	68.6
H12 de resorte especial	75.1
H14 de superresorte	80.3

Mxx—tal como se manufactura. (xx se refiere al tipo de proceso de fabricación.)

Oxx—recocida. (xx designa el método de recocido.)

OSxxx—recocida para producir un tamaño particular de grano. (xxx se refiere al diámetro del grano en 10⁻³ mm. Por tanto, OS025 señalaría un diámetro de grano de 0.025 mm.)

TB00—tratada por solución.

TF00—endurecida por envejecimiento.

TQxx—templada y revenida. (xx da detalles del tratamiento térmico.)

TABLA 10-9 Composiciones, propiedades y aplicaciones de algunas aleaciones de níquel y cobalto

Material	Resistencia a la tensión (psi)	Esfuerzo de fluencia (psi)	Elongación (%)	Aplicaciones
Ni puro (99.9% Ni)				
Recocido	30,000	16,000	45	Resistencia a la corrosión
Trabajado en frío	95,000	90,000	4	
Monel 400 (Ni-31.5% Cu)	78,000	39,000	37	Válvulas, bombas cambiadores de calor
Superalaciones de Ni				
Hastelloy B-2 (Ni-28% Mo)	130,000	60,000	61	Resistencia a la corrosión
MAR-M246 (Ni-10% Co-9% Cr-10% W + Ti, Al, Ta)	140,000	125,000	5	Motores de reacción
DS-Ni (Ni-2% ThO ₂)	71,000	48,000	14	Turbinas de gas
Superalaciones de Fe-Ni				
Incoloy 800 (Ni-46% Fe-21% Cr)	89,000	41,000	37	Cambiadores de calor
Superalaciones de Co				
Haynes 25 (50% Co-20% Cr-15% W-10% Ni)	135,000	65,000	60	Motores de reacción
Estelita 6B (60% Co-30% Cr-4.5% W)	177,000	103,000	4	Resistencia al desgaste por abrasión

TABLA 10-4 Efecto de los mecanismos de endurecimiento en el aluminio y en las aleaciones de aluminio

<i>Material</i>	<i>Resistencia a la tensión (psi)</i>	<i>Esfuerzo de fluencia (psi)</i>	<i>Elongación (%)</i>	<i>Esfuerzo de fluencia (aleación) / Esfuerzo de fluencia (puro)</i>
Aluminio puro recocido (99.999% Al)	6,500	2,500	60	
Aluminio puro comercial (recocido, 99% Al)	13,000	5,000	45	2.0
Endurecido por solución sólida (1.2% Mn)	16,000	6,000	35	2.4
Aluminio puro trabajado en frío un 75%	24,000	22,000	15	8.8
Endurecido por dispersión (5% Mg)	42,000	22,000	35	8.8
Endurecido por envejecimiento (5.6% Zn-2.5% Mg)	83,000	73,000	11	29.2

Datos modificados de *Metals Handbook*, Vol. 2, 9a. ed., American Society for Metals, 1979.

TABLA 10-7 Propiedades de aleaciones típicas de cobre obtenidas por diferentes mecanismos de endurecimiento

<i>Material</i>	<i>Designación de grado de endurecimiento</i>	<i>Resistencia a la tensión (psi)</i>	<i>Esfuerzo de fluencia (psi)</i>	<i>Elongación (%)</i>	<i>Mecanismo de endurecimiento</i>
Cobre puro, recocido		30,300	4,800	60	
Cobre comercialmente puro, recocido para engrosar el tamaño de grano	O5050	32,000	10,000	55	
Cobre comercialmente puro, recocido para afinar el tamaño de grano	O5025	34,000	11,000	55	Tamaño de grano
Cobre comercialmente puro, trabajado en frío	H10	57,000	53,000	4	Endurecimiento por deformación
Cu-35% Zn recocido	O5050	47,000	15,000	62	Solución sólida
Cu-30% Ni tal como se fabrica	M20	55,000	20,000	43	
Cu-10% Sn recocido	O5035	66,000	28,000	68	Solución sólida + Endurecimiento por deformación
Cu-35% Zn trabajado en frío	H10	98,000	63,000	3	
Cu-30% Ni trabajado en frío	H80	84,000	79,000	3	
Cu-2% Be endurecido por envejecimiento	TF00	190,000	175,000	4	Endurecimiento por envejecimiento
Cu-Al templado y revenido	TQ50	110,000	60,000	5	Reacción martensítica
Manganeso bronce fundido	F	71,000	28,000	30	Reacción eutectoide

Datos de *Metals Handbook*, Vol. 2, 9a. ed., American Society for Metals, 1979.

TABLA 10-2 Sistema de designación para las aleaciones de aluminio

Aleaciones para forja		
1xxx	Alum. comercialmente puro (>99% Al)	No envejecido
2xxx	Al-Cu	Endurecible por envejecimiento
3xxx	Al-Mn	No envejecido
4xxx	Al-Si y Al-Mg-Si	Endurecible por envejecimiento si hay magnesio presente
5xxx	Al-Mg	No envejecido
6xxx	Al-Mg-Si	Endurecible por envejecimiento
7xxx	Al-Mg-Zn	Endurecible por envejecimiento
Aleaciones fundidas		
1xx.x	Alum. comercialmente puro	No envejecido
2xx.x	Al-Cu	Endurecible por envejecimiento
3xx.x	Al-Si-Cu ó Al-Mg-Si	Algunas son endurecibles por envejecimiento
4xx.x	Al-Si	No envejecido
5xx.x	Al-Mg	No envejecido
7xx.x	Al-Mg-Zn	Endurecible por envejecimiento
8xx.x	Al-Sn	Endurecible por envejecimiento

TABLA 10-3 Propiedades de algunas aleaciones de aluminio

Aleación	Resistencia a la tensión (psi)	Esfuerzo de fluencia (psi)	Elongación (%)	Comentarios
Aleaciones para forja no tratables térmicamente				
1100-O >99% Al	13,000	5,000	40	Componentes eléctricos, hojas metálicas finas ("papel"), resistencia a la corrosión.
1100-H18	24,000	22,000	10	
3003-O 1.2% Mn	16,000	6,000	35	Latas para bebidas, aplicaciones arquitectónicas.
3003-H18	29,000	27,000	7	
4043-O 5.2% Si	21,000	10,000	22	Metal de relleno en soldadura, recipientes, componentes marinos.
5056-O 5% Mg	42,000	22,000	35	
5056-H18	60,000	30,000	15	
Aleaciones para forja tratables térmicamente				
2024-O 4.4% Cu	27,000	11,000	20	Transportes, aeronáutica, astronáutica y otras aplicaciones de alta resistencia.
2024-T4	68,000	47,000	20	
4052-T6 12% Si-1% Mg	55,000	46,000	9	
6061-T6 1% Mg-0.6% Si	45,000	40,000	15	
7075-T6 3.6% Zn-2.5% Mg	83,000	73,000	11	
Aleaciones para fundición				
295-T6 4.5% Cu-0.8% Si	36,000	24,000	5	Arena
319-F 6% Si-3.5% Cu	27,000	18,000	2	Arena
356-T6 7% Si-0.3% Mg	34,000	19,000	2.5	Molde permanente
	33,000	24,000	3.5	Arena
380-F 8.5% Si-3.5% Cu	38,000	27,000	5	Molde permanente
	46,000	23,000	3.5	Molde permanente
390-F 17% Si-4.5% Cu-0.6% Mg	41,000	35,000	1	Coquilla
443-F 5.2% Si	19,000	8,000	8	Arena
	23,000	9,000	10	Molde permanente
713-T5 7.5% Zn-0.7% Cu-0.35% Mg	33,000	16,000	9	Coquilla
	30,000	22,000	4	Arena

Datos modificados de *Metals Handbook*, Vol. 2, 9a. ed., American Society for Metals, 1979.

TABLA 10-10 Propiedades de algunas aleaciones de titanio

Material	Resistencia a la tensión (psi)	Esfuerzo de fluencia (psi)	Elongación (%)
Titanio comercialmente puro			
99.5% Ti	35,000	25,000	24
99.0% Ti	80,000	70,000	15
Aleaciones Ti alfa			
5% Al-2.5% Sn	125,000	113,000	15
Aleaciones Ti beta			
13% V-11% Cr-3% Al	187,000	176,000	5
Aleaciones Ti casi alfa			
8% Al-1% Mo-1% V	140,000	120,000	14
6% Al-4% Zr-2% Sn-2% Mo	146,000	144,000	3
Aleaciones Ti alfa-beta			
8% Mn	140,000	125,000	15
6% Al-4% V	150,000	140,000	8

Datos de Metals Handbook, Vol. 1, 2a. ed., American Society for Metals, 1980.

TABLA 10-11 Propiedades de metales refractarios

Metal	Temperatura de fusión (°C)	Densidad (g/cm³)	Temperatura ambiente			T = 1000°C	
			Resistencia a la tensión (psi)	Esfuerzo de fluencia (psi)	Elongación (%)	Resistencia a la tensión (psi)	Esfuerzo de fluencia (psi)
Nb	2470	8.56	45,000	20,000	25	17,000	9,000
Mo	2610	10.22	120,000	50,000	10	50,000	30,000
Ti	2996	4.5	50,000	35,000	35	27,000	24,000
W	3410	19.25	300,000	220,000	3	66,000	15,000

PARTE 1 — METALES (Tomados de medios numerosos)

Material	Densidad	Conductividad térmica cal/cm °C·cm²·seg a 20°C*	Expansión térmica plg/plg/°F a 20°C†	Resistividad eléctrica en ohm·cm a 20°C‡	Módulo de elasticidad promedio, lb/plg² a 20°C
Aluminio (99.9+)	2.7	0.53	12.5×10^{-6}	2.9×10^{-6}	10×10^6
Aleaciones Al	2.7(+)	0.4(±)	12×10^{-6}	3.5×10^{-6} (÷)	10×10^6
Latón (70Cu-30Zn)	8.5	0.3	11×10^{-6}	6.2×10^{-6}	16×10^6
Bronce (95Cu-5Sn)	8.5	0.2	10×10^{-6}	9.6×10^{-6}	16×10^6
Cobre (99.9+)	8.9	0.95	9×10^{-6}	1.7×10^{-6}	16×10^6
Hierro (99.9+)	7.87	0.18	6.53×10^{-6}	9.7×10^{-6}	29×10^6
Plomo (99+)	11.34	0.08	16×10^{-6}	20.65×10^{-6}	2×10^6
Magnesio (99+)	1.74	0.38	14×10^{-6}	4.5×10^{-6}	6.5×10^6
Monel (70Ni-30Cu)	8.8	0.06	8×10^{-6}	48.2×10^{-6}	26×10^6
Plata (sterling)	10.4	1.0	10×10^{-6}	1.8×10^{-6}	11×10^6

TABLA B.1. PROPIEDADES MECANICAS DE LOS METALES NO FERROSOS *

Metal	Resistencia a la cedencia por tensión, lb/plg ²	Resistencia a la tensión, lb/plg ²	Módulo de elasticidad en tensión, 10 ⁶ lb/plg ²	Elongación en 2 plg. porcentaje	No. de dureza de Brinell	Peso, lb/plg ³
Cobre, 0.25 plg grueso:						
Recocido grano de 0.05 mm	10 000	32 000	16	45	47	0.320
Duro	45 000	50 000	10	12	105	0.320
Níquel:						
Recocido en caliente	25 000	75 000	30	45	110	0.310
Recocido duro	120 000	140 000	30	2	...	0.319
Cinc:						
Vaciado	6 000	11	1	...	0.260
Lámina rodada dura	5 000	24 000	12	35	...	0.260
Aluminio:						
Vaciado en arena, 1100-F	6 000	11 000	9	22	...	0.097
Lámina recocida, 1100-O	5 000	13 000	10	35	23	0.097
Lámina dura, 1100-H18	21 000	24 000	10	5	44	0.097
Magnesio:						
Vaciado	600	13 000	6	6	50	0.063
Extruido	1 200	26 000	6	8	35	0.063
Rolado	3 000	25 000	6	4	40	0.063

TABLA B.2. PROPIEDADES MECANICAS DE LAS ALEACIONES PESADAS NO FERROSAS *

Aleación	Composición aproximada, porcentajes	Resistencia a la cedencia por tensión, lb/plg ²	Resistencia a la tensión, lb/plg ²	Módulo de elasticidad por tensión, 10 ⁶ lb/plg ²	Porcentaje de elongación en 2 plg	Resistencia al corte, lb/plg ²	Número de dureza Rockwell	Peso, lb/plg ³
Latón para corte libre:								
Recocido	Cobre 61.5; cinc 35.5; plomo 3	18 000	49 000	12	53	30 000	F68	0.30
1/4 duro 15% de reducción		45 000	56 000	12	20	33 000	B62	0.30
Medio duro, 25% de reducción		52 000	68 000	14	18	38 000	B80	0.30
Latón con alto contenido de plomo (0.04 plg de grueso):								
Recocido, grano de 0.050 mm	Cobre 65; cinc 33; plomo 2	15 000	47 000	12	55	33 000	F66	0.30
Extraduro		62 000	55 000	15	5	45 000	B37	0.30
Latón rojo (0.04 plg de grueso):								
Recocido, grano de 0.070 mm	Cobre 85; cinc 15	10 000	39 000	12	48	31 000	F66	0.31
de grueso extra duro		61 000	78 000	15	4	44 000	B83	0.31
Bronce al aluminio:								
Vaciado en arena	Cobre 89; aluminio 8; hierro 3	28 000	75 000	40	0.30
Extruido		37 500	82 000	18	25	0.30
Cobre al berilio:								
A (solución recocida)	Cobre 97.9; berilio 1.9; níquel 0.2	70 000 ±	18	35	B60 ±	0.32
H.T. endurecido		150 000	200 000	18	2	C42	0.32
Bronce al manganeso (A):								
Recocido, suave, duro 15% de reducción	Cobre 58.5; cinc 39; hierro 1.4; estaño 1; manganeso 0.1	30 000	65 000	13	35	42 000	B65	0.30
		60 000	82 000	15	25	47 000	B90	0.30
Bronce al fósforo, 5% (A):								
Recocido, grano de 0.035 mm	Cobre 95; estaño 5	22 000	49 000	13	57	B33	0.32
Extraduro, grano de 0.015 mm		92 000	94 000	17	5	B94	0.32
Cuproníquel, 30%:								
Recocido a 1400°F. Laminado en frío, 50% de reducción	Cobre 70; níquel 30	20 000	55 000	22	45	B37	0.32
		78 000	85 000	22	15	B81	0.32

TABLA 10-14 Composiciones y propiedades de algunos aceros Inoxidables

Acero	% C	% Cr	% Ni	Otros	Resistencia a la tensión (psi)	Esfuerzo de fluencia (psi)	Elongación (%)
Austenítico							
201	0.15	16-18	3.5-5.5	5.5-7.5% Mn	95,000	45,000	40
304	0.08	18-20	8.0-10.5		75,000	30,000	30
304L	0.03	18-20	8-12		75,000	30,000	30
321	0.08	17-19	9-12	Ti (5 × % C)	85,000	35,000	55
347	0.08	17-19	9-13	Nb (10 × % C)	90,000	35,000	50
Ferrítico							
430	0.12	16-18			65,000	30,000	22
442	0.12	18-23			75,000	40,000	20
Martensítico							
416	0.15	12-14		0.60% Mo	180,000	140,000	18
431	0.20	15-17	1.25-2.50		200,000	150,000	16
440C	0.95-1.2	16-18		0.75% Mo	285,000	273,000	2
Endurecimiento por precipitación							
17-4	0.07	16-18	3-5	0.15-0.45% Nb	190,000	170,000	10
17-7	0.09	16-18	6.5-7.8	0.75-1.25% Al	240,000	230,000	6

Modificada a partir de *Metals Handbook*, Vol. 3, 9a. ed., American Society for Metals, 1980

TABLA 10-15 Propiedades representativas de fundiciones típicas

Clasificación	Resistencia a la tensión (psi)	Esfuerzo de fluencia (psi)	% A	
Clase 20, fundición gris	12,000-40,000		<1	CE > 4.2%
Clase 40, fundición gris	28,000-54,000		<1	CE < 4.0%
35018, fundición maleable	55,000	35,000	18	Ferrita
90001, fundición maleable	105,000	90,000	1	Martensita revenida
60-40-18, fundición dúctil	60,000	40,000	18	Ferrita
120-90-02, fundición dúctil	120,000	90,000	2	Martensita revenida
Fundición de grafito grado B compactada	50,000	40,000	1	Ferrita + perlita

TABLA A. 2. PROPIEDADES MECANICAS DEL HIERRO Y DEL ACERO*

Material	Resistencia a la tensión, kips/plg ²		Resistencia a la cedencia por compresión kips/plg ²	Resistencia al corte por torsión, kips/plg ²		Módulo de elasticidad, 10 ⁶ lb/plg ²		Porcentaje de elongación en 2 plg	Número de dureza de Brinell	Módulo de tenacidad lb-plg/plg ²	Límite de duración de flexión invertida, kips/plg ²
	Resis. a la cedencia	Última		Resis. a la cedencia	Última	Tensión	Corte				
Fundición gris	...	20	35	...	37	15	6	1	130	80	11
Fundición blanca	...	60	100	...	60	20	8	...	400		
Fundición al níquel, 1.5% de níquel	...	45	60	20	8	1	200		
Hierro maleable	33	50	33	19	48	25	10	14	120		26
Hierro en lingotes, recocido, 0.02% de carbono	24	42	21	15	30	30	12	45	70		26
Hierro forjado, 0.10% de carbono	30	50	30	18	35	27	10	30	100	14 000	25
Acero, 0.20% de carbono:											
Rolado en caliente	40	60	40	24	45	30	12	35	120	16 500	31
Rolado en frío	60	80	60	36	60	30	12	15	160	12 000	40
Fundiciones recocidas	35	60	35	21	45	30	12	25	130		
Acero, 0.40% de carbono:											
Rolado en caliente	42	70	42	25	55	30	12	25	135		
Tratamiento térmico para grano fino	60	90	60	36	75	30	12	25	190		
Fundiciones recocidas	35	65	35	21	55	30	12	15	130		
Acero, 0.60% de carbono:											
Rolado en caliente	67	100	63	37	80	30	12	15	200	12 300	50
Con tratamiento térmico para grano fino	78	120	78	47	100	30	12	15	235	15 000	55
Acero, 0.80% de carbono:											
Rolado en caliente	73	120	73	44	105	30	12	10	240		
Apagado en aceite, no laminado	125	150	125	75	150	30	12	2	300		
Acero 1.00% de carbono:											
Rolado en caliente	87	135	83	50	115	30	12	10	260	11 000	60
Apagado en aceite, no laminado	140	200	140	80	185	30	12	1	350	2 000	800
Acero al níquel, 3.3% de níquel, 0.40% de carbono, máxima dureza para maquinabilidad	170	170	150	90	140	30	12	12	350	14 000	75
Acero al silicomanganeso, 1.35% de silicio, 0.70% de Mn, templado para resortes	130	174	130	73	115	30	12	1	360	21 000	

Nota: La mayoría de los aceros dependen tanto del tratamiento térmico como de su composición para desarrollar propiedades mecánicas particulares.

TABLA A.3. REQUERIMIENTOS PARA FUNDICIONES DE HIERRO GRIS *

Clase No.	Resistencia a la tensión lb/plg ²	Carga de ruptura por flexión al centro, mínima, libras		
		0.875 plg de diám, claro de 12 plg	1.2 plg de diám, claro de 18 plg	2.0 plg de diám, claro de 24 plg
20	20 000	900	1 800	6 000
25	25 000	1 025	2 000	6 800
30	30 000	1 150	2 200	7 600
35	35 000	1 275	2 400	8 300
40	40 000	1 400	2 600	9 100
50	50 000	1 675	3 000	10 300
60	60 000	1 925	3 400	12 500

* Basado en ASTM A 48.

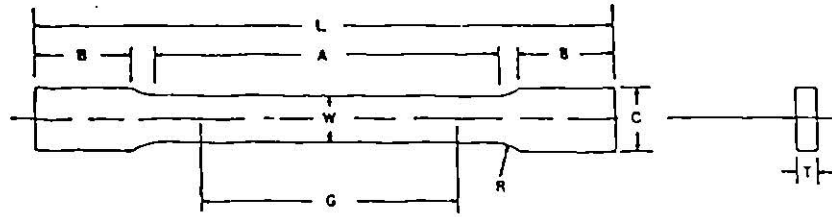

Dimensions

	Standard Specimens		Subsize Specimen
	Plate-Type, 1½-in. Wide	Sheet-Type, ½-in. Wide	¼-in. Wide
	in.	in.	in.
G—Gage length (Notes 1 and 2)	8.00 ± 0.01	2.000 ± 0.005	1.000 ± 0.003
W—Width (Notes 3 and 4)	1½ + ¼, -¼	0.500 ± 0.010	0.250 ± 0.005
T—Thickness (Note 5)		thickness of material	
R—Radius of fillet, min (Note 6)	1	½	¼
L—Over-all length, min (Notes 2 and 7)	18	8	4
A—Length of reduced section, min	9	2¼	1¼
B—Length of grip section, min (Note 8)	3	2	1¼
C—Width of grip section, approximate (Notes 4 and 9)	2	¾	¾

NOTE 1—For the 1½-in. wide specimen, punch marks for measuring elongation after fracture shall be made on the flat or on the edge of the specimen and within the reduced section. Either a set of nine or more punch marks 1 in. apart, or one or more pairs of punch marks 8 in. apart may be used.

NOTE 2—When elongation measurements of 1½-in. wide specimens are not required, a minimum length of reduced section (A) of 2¼ in. may be used with all other dimensions similar to those of the plate-type specimen.

NOTE 3—For the three sizes of specimens, the ends of the reduced section shall not differ in width by more than 0.004, 0.002 or 0.001 in., respectively. Also, there may be a gradual decrease in width from the ends to the center, but the width at each end shall not be more than 0.015, 0.005, or 0.003 in., respectively, larger than the width at the center.

NOTE 4—For each of the three sizes of specimens, narrower widths (W and C) may be used when necessary. In such cases the width of the reduced section should be as large as the width of the material being tested permits; however, unless stated specifically, the requirements for elongation in a product specification shall not apply when these narrower specimens are used.

NOTE 5—The dimension T is the thickness of the test specimen as provided for in the applicable material specifications. Minimum thickness of 1½-in. wide specimens shall be ¼ in. Maximum thickness of ½-in. and ¼-in. wide specimens shall be ¾ in. and ¼ in., respectively.

NOTE 6—For the 1½-in. wide specimen, a ½-in. minimum radius at the ends of the reduced section is permitted for steel specimens under 100 000 psi in tensile strength when a profile cutter is used to machine the reduced section.

NOTE 7—To aid in obtaining axial loading during testing of ¼-in. wide specimens, the over-all length should be as large as the material will permit, up to 8.00 in.

NOTE 8—It is desirable, if possible, to make the length of the grip section large enough to allow the specimen to extend into the grips a distance equal to two thirds or more of the length of the grips. If the thickness of ½-in. wide specimens is over ¾ in., longer grips and correspondingly longer grip sections of the specimen may be necessary to prevent failure in the grip section.

NOTE 9—For the three sizes of specimens, the ends of the specimen shall be symmetrical in width with the center line of the reduced section within 0.10, 0.05 and 0.005 in., respectively. However, for referee testing and when required by product specifications, the ends of the ½-in. wide specimen shall be symmetrical within 0.01 in.

NOTE 10—Specimens with sides parallel throughout their length are permitted, except for referee testing, provided, (a) the above tolerances are used; (b) an adequate number of marks are provided for determination of elongation; and (c) when yield strength is determined, a suitable extensometer is used. If the fracture occurs at a distance of less than 2W from the edge of the gripping device, the tensile properties determined may not be representative of the material. In acceptance testing, if the properties meet the minimum requirements specified, no further testing is required, but if they are less than the minimum requirements, discard the test and retest.

FIG. 1 Rectangular Tension Test Specimens

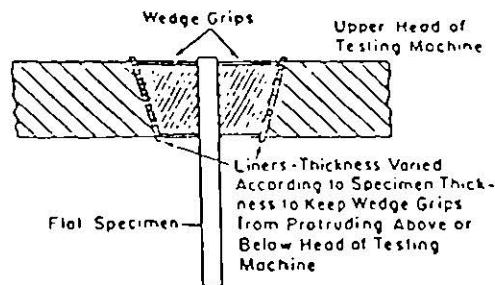
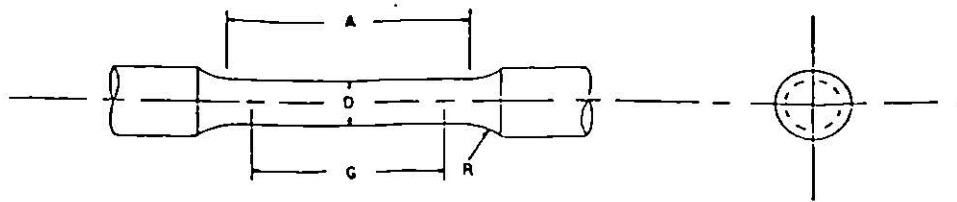

FIG. 2 Wedge Grips with Liners for Flat Specimens



	Dimensions				
	Standard Specimen	Small-Size Specimens Proportional to Standard			
	in.	in.	in.	in.	in.
Nominal Diameter	0.500	0.350	0.250	0.160	0.113
G—Gage length	2.000 ± 0.005	1.400 ± 0.005	1.000 ± 0.005	0.640 ± 0.005	0.450 ± 0.005
D—Diameter (Note 1)	0.500 ± 0.010	0.350 ± 0.007	0.250 ± 0.005	0.160 ± 0.003	0.113 ± 0.002
R—Radius of fillet, min	3/8	1/4	3/16	5/32	3/32
A—Length of reduced section, min (Note 2)	2 1/4	1 3/4	1 1/4	3/4	5/8

NOTE 1—The reduced section may have a gradual taper from the ends toward the center, with the ends not more than 1% larger in diameter than the center (controlling dimension).

NOTE 2—If desired, the length of the reduced section may be increased to accommodate an extensometer of any convenient gage length. Reference marks for the measurement of elongation should, nevertheless, be spaced at the indicated gage length.

NOTE 3—The gage length and fillets may be as shown, but the ends may be of any form to fit the holders of the testing machine in such a way that the load shall be axial (see Fig. 9). If the ends are to be held in wedge grips it is desirable, if possible, to make the length of the grip section great enough to allow the specimen to extend into the grips a distance equal to two thirds or more of the length of the grips.

NOTE 4—On the round specimens in Figs. 8 and 9, the gage lengths are equal to four times the nominal diameter. In some product specifications other specimens may be provided for, but unless the 4-to-1 ratio is maintained within dimensional tolerances, the elongation values may not be comparable with those obtained from the standard test specimen.

NOTE 5—The use of specimens smaller than 0.250-in. diameter shall be restricted to cases when the material to be tested is of insufficient size to obtain larger specimens or when all parties agree to their use for acceptance testing. Similar specimens require suitable equipment and greater skill in both machining and testing.

NOTE 6—Five sizes of specimens often used have diameters of approximately 0.505, 0.357, 0.252, 0.160 and 0.113 in., the reason being to permit easy calculation of stresses from loads, since the corresponding cross-sectional areas are equal or close to 0.200, 0.100, 0.0500, 0.0200 and 0.0100 in.² respectively. Thus, when the actual diameters agree with these values, the stresses (or strengths) may be computed using the simple multiplying factors 5, 10, 20, 50, and 100, respectively. The main advantage of these five diameters do not result in correspondingly convenient cross-sectional areas and multiplying factors.

FIG. 8 Standard 0.500-in. Round Tension Test Specimen with 2-in. Gage Length and Examples of Small-Size Specimens Proportional to the Standard Specimen

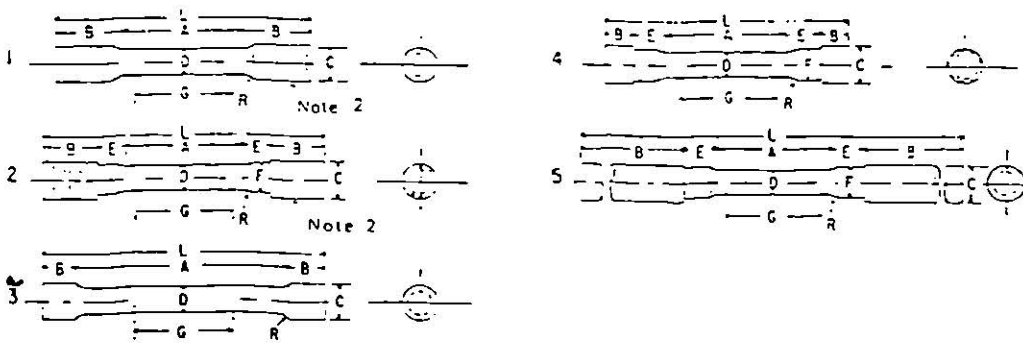

	Dimensions				
	Specimen 1	Specimen 2	Specimen 3	Specimen 4	Specimen 5
	in.	in.	in.	in.	in.
G—Gage length	2.000 ± 0.005	2.000 ± 0.005	2.000 ± 0.005	2.000 ± 0.005	2.000 ± 0.005
D—Diameter (Note 1)	0.500 ± 0.010	0.500 ± 0.010	0.500 ± 0.010	0.500 ± 0.010	0.500 ± 0.010
R—Radius of fillet, min	3/8	3/8	3/16	3/8	3/8
A—Length of reduced section	2 1/4, min	2 1/4, min	4, approximately	2 1/4, min	2 1/4, min
L—Over-all length, approximate	5	5 1/2	5 1/2	4 3/4	5 1/2
E—Length of end section (Note 2)	1 3/8, approximately	1, approximately	3/4, approximately	1/2, approximately	3, min
C—Diameter of end section	3/4	3/4	7/32	7/8	3/4
E—Length of shoulder and fillet section, approximate	...	3/8	...	3/4	3/8
F—Diameter of shoulder	...	3/8	...	3/8	11/32

NOTE 1—The reduced section may have a gradual taper from the ends toward the center with the ends not more than 0.005 in. larger in diameter than the center.

NOTE 2—On Specimens 1 and 2, any standard thread is permissible that provides for proper alignment and aids in assuring that the specimen will break within the reduced section.

NOTE 3—On Specimen 5 it is desirable, if possible, to make the length of the grip section great enough to allow the specimen to extend into the grips a distance equal to two thirds or more of the length of the grips.

FIG. 9 Various Types of Ends for Standard Round Tension Test Specimens

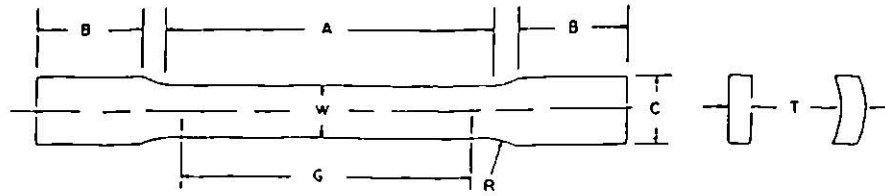

	Dimensions						
	Specimen 1	Specimen 2	Specimen 3	Specimen 4	Specimen 5	Specimen 6	Specimen 7
	in.	in.	in.	in.	in.	in.	in.
—Gage length	2.000 ± 0.005	2.000 ± 0.005	8.00 ± 0.01	2.000 ± 0.005	4.000 ± 0.005	2.000 ± 0.005	4.000 ± 0.005
—Width (Note 1)	0.500 ± 0.010	1½ ± ¼, -¼	1½ ± ¼, -¼	0.750 ± 0.031	0.750 ± 0.031	1.000 ± 0.062	1.000 ± 0.062
—Thickness	measured thickness of specimen						
—Radius of fillet, min	½	1	1	1	1	1	1
—Length of reduced section, min	2¼	2¼	9	2¼	4½	¾	4½
—Length of grip section, min (Note 2)	3	3	3	3	3	3	3
—Width of grip section, approximate (Note 3)	1¼	2	2	1	1	1½	1½

Note 1—The ends of the reduced section shall differ in width by not more than 0.002 in. for specimens 1, 4, and not more than 0.005 in. for specimens 2, 3, 5, 6, 7. There may be a gradual taper in width from the ends to the center, but the width at each end shall be not more than 0.005 in. greater than the width at the center for 2-in. gage length specimens, not more than 0.008 in. greater than the width at the center for 4-in. gage length specimens, and not more than 0.015 in. greater than the width at the center for 8-in. gage length specimens.

Note 2—It is desirable, if possible, to make the length of the grip section great enough to allow the specimen to extend into the grips a distance equal to two thirds or more of the length of the grips.

Note 3—The ends of the specimen shall be symmetrical with the center line of the reduced section within 0.05 in. for specimens 1, 4, and 5, and 0.10 in. for specimens 2, 3, 6, and 7.

Note 4—For circular segments, the cross-sectional area may be calculated by multiplying W and T . If the ratio of the dimension W to the diameter of the tubular section is larger than about ¼, the error using this method to calculate the cross-sectional area may be appreciable and it may be desirable to use a more exact method of determining the area.

Note 5—Specimens with G/W less than 4 should not be used for determination of elongation.

Note 6—Specimens with sides parallel throughout their length are permitted, except for where the testing procedure requires the use of a reduced section or marks are provided for determination of elongation; and (b) when yield strength is determined, a outside extensometer is used. If fracture occurs at a distance of less than $2W$ from the edge of the gripping device, the tensile properties determined may not be representative of the material. If the properties meet the minimum requirements specified, no further testing is required, but if they are less than the minimum requirements, discard the test and retest.

FIG. 13 Tension Test Specimens for Large-Diameter Tubular Products

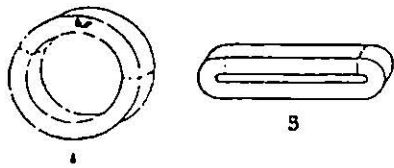
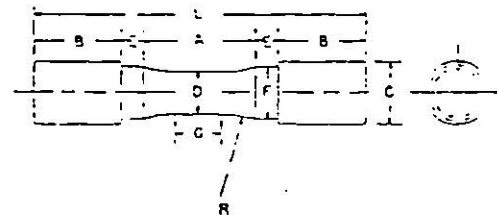

FIG. 14 Location of Transverse Tension Test Specimen in Ring Cut from Tubular Products



	Dimensions		
	Specimen 1	Specimen 2	Specimen 3
	in.	in.	in.
G—Length of parallel section	Shall be equal to or greater than diameter D		
D—Diameter	0.500 ± 0.010	0.750 ± 0.015	1.25 ± 0.02
R—Radius of fillet, min	1	1	2
A—Length of reduced section, min	1¼	1½	2¼
L—Over-all length, min	3¾	4	6¾
B—Length of end section, approximate	1	1	1¾
C—Diameter of end section, approximate	¾	1½	1¾
E—Length of shoulder, min	¼	½	¾
F—Diameter of shoulder	¾ ± ¼	1½ ± ¼	1¾ ± ¼

NOTE—The reduced section and shoulders (dimensions A , D , E , F , G , and R) shall be as shown, but the ends may be of any form to fit the holders of the testing machine in such a way that the load can be axial. Commonly the ends are threaded and have the dimensions B and C given above.

FIG. 15 Standard Tension Test Specimen for Cast Iron

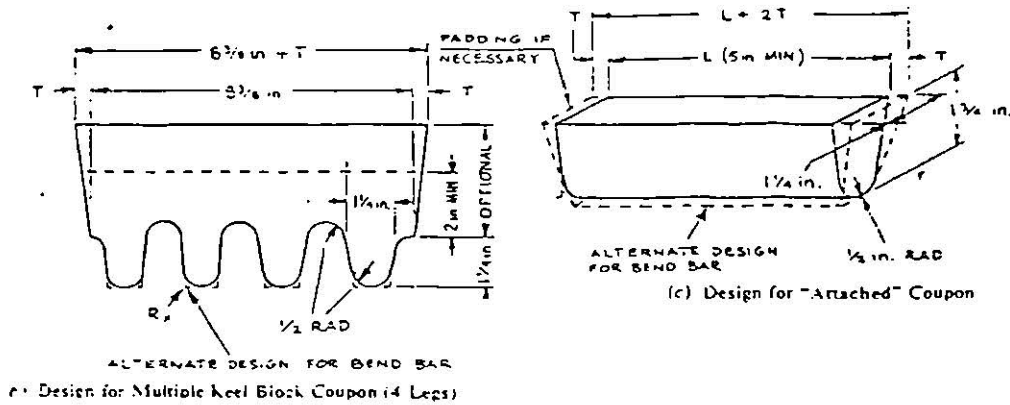
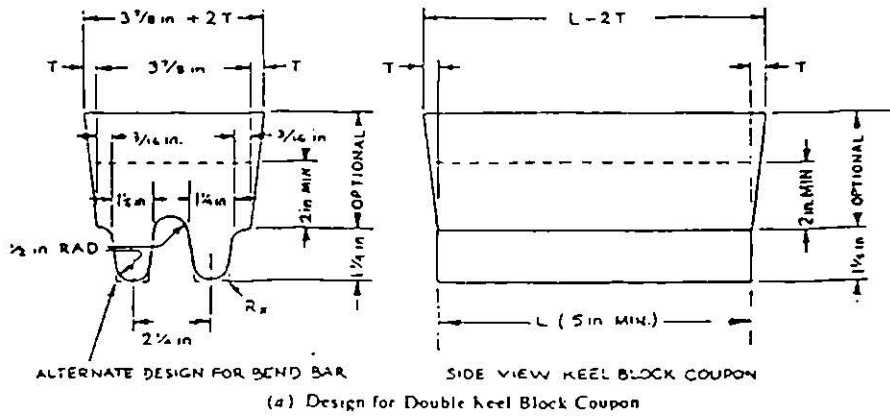
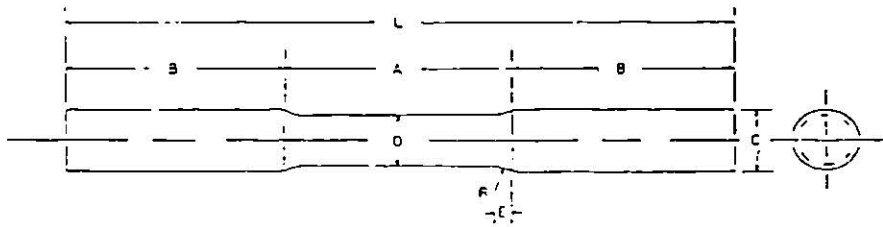

FIG. 16 Test Coupons for Castings (see Table 1 for Details of Design)



Dimensions

	in.
D—Diameter	5/8
R—Radius of fillet	3/16
A—Length of reduced section	2 1/2
L—Over-all length	7 1/2
B—Length of end section	2 1/2
C—Diameter of end section	3/8
E—Length of fillet	3/16

FIG. 17 Standard Tension Test Specimen for Malleable Iron

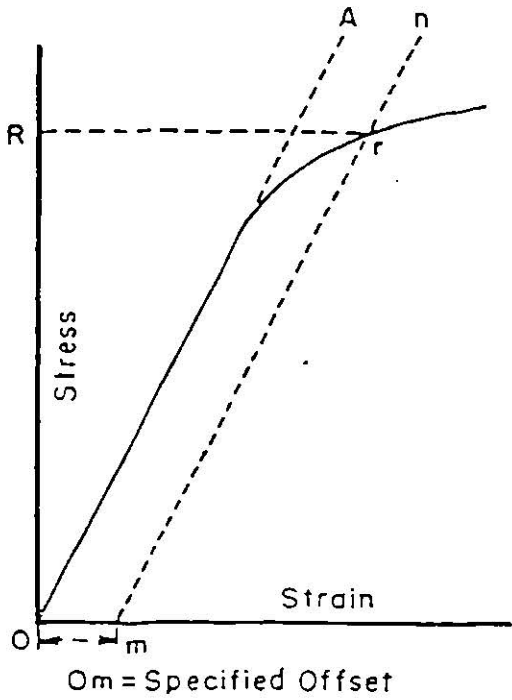

FIG. 21 Stress-Strain Diagram for Determination of Yield Strength by the Offset Method

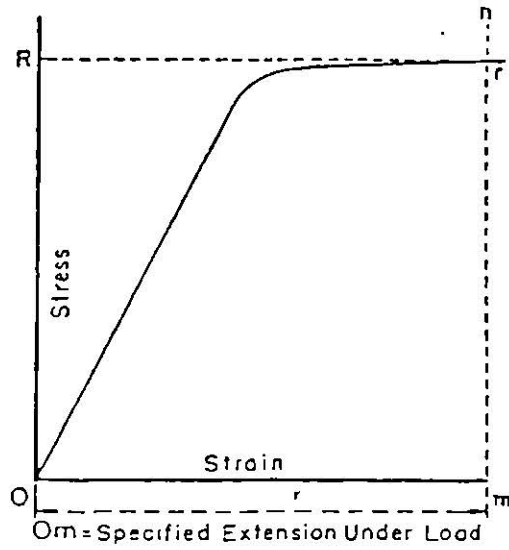

FIG. 22 Stress-Strain Diagram for Determination of Yield Strength or Yield Point by the Extension-Under-Load Method

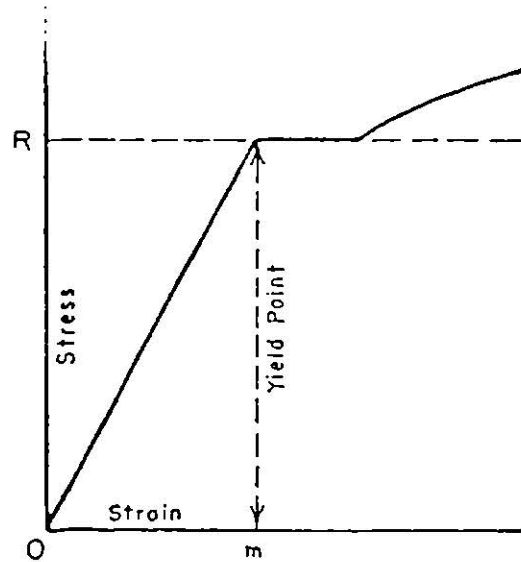

FIG. 23 Stress-Strain Diagram Showing Yield Point Corresponding with Top of Knee

INDENTED STEEL AND IRON ALLOYS

C	A	D	15-N	30-N	45-N	HV	HK	HB	G	KSI	WMN
150 kg Brale	60 kg Brale	100 kg Brale	15 kg N Brale	30 kg N Brale	45 kg N Brale	Vickers 10 kg	500 gm & over	3000 kg. 10mm ball	150 kg 1/16" ball	1000 lbs/sq. in.	1000 gm
Rockwell	Rockwell	Rockwell	Superficial	Superficial	Superficial	Vickers	Knoop	Brinell	Rockwell	Tensile Strength	Microficial
80	92.0	86.5	96.5	92.0	87.0	1865	—	—	—	—	—
79	91.5	85.5	96.3	91.5	86.5	1787	—	—	—	—	—
78	91.0	84.5	96.0	91.0	85.5	1710	—	—	—	—	—
77	90.5	84.0	95.8	90.5	84.5	1633	—	—	—	—	—
76	90.0	83.0	95.5	90.0	83.5	1556	—	—	—	—	—
75	89.5	82.5	95.3	89.0	82.5	1478	—	—	—	—	—
74	89.0	81.5	95.0	88.5	81.5	1400	—	—	—	—	—
73	88.5	81.0	94.8	88.0	80.5	1323	—	—	—	—	—
72	88.0	80.0	94.5	87.0	79.5	1245	—	—	—	—	—
71	87.0	79.5	94.3	86.5	78.5	1160	—	NOTE 1	—	NOTE 2	—
70	86.5	78.5	94.0	86.0	77.5	1076	972	—	—	—	953
69	86.0	78.0	93.5	85.0	76.5	1004	946	—	—	—	949
68	85.6	76.9	93.2	84.4	75.4	940	920	—	—	—	945
67	85.0	76.1	92.9	83.6	74.2	900	895	—	—	—	942
66	84.5	75.4	92.5	82.8	73.3	865	870	NA	—	—	938
65	83.9	74.5	92.2	81.9	72.0	832	846	739	—	—	934
64	83.4	73.8	91.8	81.1	71.0	800	822	722	—	—	930
63	82.8	73.0	91.4	80.1	69.9	772	799	706	—	—	926
62	82.3	72.2	91.1	79.3	68.8	746	776	688	—	—	922
61	81.8	71.5	90.7	78.4	67.7	720	754	670	—	—	917
60	81.2	70.7	90.2	77.5	66.6	697	732	654	—	NA	913
59	80.7	69.9	89.8	76.6	65.5	674	710	634	—	351	909
58	80.1	69.2	89.3	75.7	64.3	653	690	615	—	338	904
57	79.6	68.5	88.9	74.8	63.2	633	670	595	—	325	900
56	79.0	67.7	88.3	73.9	62.0	613	650	577	—	313	896
55	78.5	66.9	87.9	73.0	60.9	595	630	560	—	301	891
54	78.0	66.1	87.4	72.0	59.8	577	612	543	—	292	887
53	77.4	65.4	86.9	71.2	58.6	560	594	525	—	283	883
52	76.8	64.6	86.4	70.2	57.4	544	576	512	—	273	879
51	76.3	63.8	85.9	69.4	56.1	528	558	496	—	264	874
50	75.9	63.1	85.5	68.5	55.0	513	542	481	—	255	870
49	75.2	62.1	85.0	67.6	53.8	498	526	469	—	246	865
48	74.7	61.4	84.5	66.7	52.5	484	510	455	—	238	861
47	74.1	60.8	83.9	65.8	51.4	471	495	443	—	229	856
46	73.6	60.0	83.5	64.8	50.3	458	480	432	—	221	851
45	73.1	59.2	83.0	64.0	49.0	446	466	421	—	215	847
44	72.5	58.5	82.5	63.1	47.8	434	452	409	—	208	842
43	72.0	57.7	82.0	62.2	46.7	423	438	400	—	201	837
42	71.5	56.9	81.5	61.3	45.5	412	426	390	—	194	832
41	70.9	56.2	80.9	60.4	44.3	402	414	381	—	188	827
40	70.4	55.4	80.4	59.5	43.1	392	402	371	—	182	822
39	69.9	54.6	79.9	58.6	41.9	382	391	362	—	177	817
38	69.4	53.8	79.4	57.7	40.8	372	380	353	—	171	812
37	68.9	53.1	78.8	56.8	39.6	363	370	344	—	166	807
36	68.4	52.3	78.3	55.9	38.4	354	360	336	—	161	802
35	67.9	51.5	77.7	55.0	37.2	345	351	327	—	156	798
34	67.4	50.8	77.2	54.2	36.1	336	342	319	—	152	793
33	66.8	50.0	76.6	53.3	34.9	327	334	311	—	149	788
32	66.3	49.2	76.1	52.1	33.7	318	326	301	—	146	783
31	65.8	48.4	75.6	51.3	32.5	310	318	294	NA	141	778
30	65.3	47.7	75.0	50.4	31.3	302	311	286	92.0	138	773
29	64.6	47.0	74.5	49.5	30.1	294	304	279	91.0	135	768
28	64.3	46.1	73.9	48.6	28.9	286	297	271	90.0	131	762
27	63.8	45.2	73.3	47.7	27.8	279	290	264	89.0	128	757
26	63.3	44.6	72.8	46.8	26.7	272	284	258	88.0	125	751
25	62.8	43.8	72.2	45.9	25.5	266	278	253	87.0	123	746
24	62.4	43.1	71.6	45.0	24.3	260	272	247	86.0	119	741
23	62.0	42.1	71.0	44.0	23.1	254	266	243	84.5	117	736
22	61.5	41.6	70.5	43.2	22.0	248	261	237	83.5	115	730
21	61.0	40.9	69.9	42.3	20.7	243	256	231	82.5	112	725
20	60.5	40.1	69.4	41.5	19.6	238	251	226	81.0	110	720

Although conversion tables dealing with hardness can only be approximate, it is of considerable value to be able to compare different hardness scales. This table is based on the assumption that the metal tested is homogeneous to a depth several times as great as the depth of the indentation.

The indentation hardness values measured on the various scales depend on the work hardening behavior of the material during the test, and this in turn depends on the degree of previous cold working of the material. The B-scale relationships in the table are based largely on annealed metals for the low values and cold worked metals for the higher values. Therefore, these relationships are not applicable to materials which have been cold worked.

Soft steel, grey and malleable cast iron and most non-ferrous metals

	1/16" Ball 60 kg 1/16" ball	G 150 kg 1/16" ball	15-T 15 kg 1/16" ball	30-T 30 kg 1/16" ball	45-T 45 kg 1/16" ball	F 100 kg 1/8" ball	H 60 kg 1/8" ball	K 150 kg 1/8" ball	A 60 kg Brake	HK 500 gm & over	HB 500 kg 10mm ball	H _a 3000 kg 10 kg 10 mm ball	KSI 1000 lbs/sq. in.	W.M.N. 1000 gm
Rockwell	Rockwell	Rockwell	Superficial	Superficial	Superficial	Rockwell	Rockwell	Rockwell	Rockwell	Knoop	Brinell	Brinell 10mm Vickers 136°	Tensile Strength	Microficial
99	↑	82.5	93.1	83.1	72.9	↑	↑	↑	61.5	251	201	240	116	730
98	↑	81.0	92.8	82.5	71.9	↑	↑	↑	60.9	246	195	234	114	725
97	↑	79.0	92.5	81.8	70.9	↑	↑	↑	60.2	241	189	228	109	719
96	↑	77.5	92.1	81.1	69.9	↑	↑	↑	59.5	236	184	222	104	713
95	↑	76.0	91.8	80.4	68.9	↑	↑	↑	58.9	231	179	216	102	707
94	↑	74.0	91.5	79.8	67.9	↑	↑	↑	58.3	226	175	210	100	701
93	↑	72.5	91.2	79.1	66.9	↑	↑	↑	57.6	221	171	205	98	696
92	↑	71.0	90.8	78.4	65.9	↑	↑	↑	57.0	216	167	200	94	690
91	↑	69.0	90.5	77.8	64.8	↑	↑	↑	56.4	211	163	195	92	684
90	↑	67.5	90.2	77.1	63.8	↑	↑	↑	55.8	206	160	190	90	679
89	↑	66.0	89.9	76.4	62.8	↑	↑	↑	55.2	201	157	185	89	674
88	↑	64.0	89.5	75.8	61.3	↑	↑	↑	54.6	196	154	180	88	668
87	↑	62.5	89.2	75.1	60.8	↑	↑	↑	54.0	192	151	176	86	662
86	↑	61.0	88.9	74.4	59.8	↑	↑	↑	53.4	188	148	172	84	656
85	↑	59.0	88.6	73.8	58.8	↑	↑	↑	52.8	184	145	169	83	651
84	↑	57.5	88.2	73.1	57.8	↑	↑	↑	52.3	180	142	165	82	646
83	↑	56.0	87.9	72.4	56.8	↑	↑	↑	51.7	176	140	162	81	640
82	↑	54.0	87.6	71.8	55.8	↑	↑	↑	51.1	173	137	159	80	634
81	↑	52.5	87.3	71.1	54.8	↑	↑	↑	50.6	170	135	156	77	629
80	↑	51.0	86.9	70.4	53.8	↑	↑	↑	50.0	167	133	153	73	624
79	↑	49.0	86.6	69.7	52.8	↑	↑	↑	49.5	164	130	150	72	618
78	↑	47.5	86.3	69.1	51.8	↑	↑	↑	48.9	161	128	147	70	612
77	↑	46.0	86.0	68.4	50.8	↑	↑	↑	48.4	158	126	144	69	607
76	↑	44.0	85.6	67.7	49.8	↑	↑	↑	47.9	155	124	141	68	602
75	NA	42.5	85.3	67.1	48.8	↑	↑	↑	47.3	152	122	139	67	596
74	99.6	41.0	85.0	66.4	47.8	↑	↑	↑	46.8	150	120	137	66	592
73	99.1	39.0	84.7	65.7	46.8	↑	↑	↑	46.3	147	118	135	65	587
72	98.5	37.5	84.3	65.1	45.8	↑	↑	↑	45.8	145	116	132	64	581
71	98.0	36.0	84.0	64.4	44.8	NA	↑	↑	45.3	143	114	130	63	576
70	97.4	34.5	83.7	63.7	43.8	100	↑	↑	44.8	141	112	127	62	571
69	96.8	32.5	83.4	63.1	42.8	99.5	↑	↑	44.3	139	110	125	61	566
68	96.2	31.0	83.0	62.4	41.8	99.0	↑	↑	43.8	137	109	123	60	561
67	95.6	29.5	82.7	61.7	40.8	98.0	↑	↑	43.3	135	107	121	59	556
66	95.1	28.0	82.4	61.0	39.8	97.5	↑	↑	42.8	133	106	119	58	551
65	94.5	26.5	82.1	60.4	38.7	97.0	↑	↑	42.3	131	104	117	57	546
64	93.9	25.0	81.8	59.7	37.7	96.0	↑	↑	41.8	129	102	116	56	542
63	93.4	23.5	81.4	59.0	36.7	95.5	↑	↑	41.4	127	101	114	NA	537
62	92.8	22.0	81.1	58.4	35.7	95.0	↑	↑	40.9	125	99	112	532	532
61	92.2	20.5	80.8	57.7	34.7	94.5	↑	↑	40.4	124	98	110	527	527
60	91.7	19.0	80.5	57.0	33.7	93.5	↑	↑	40.0	122	96	108	522	522
59	91.1	17.5	80.1	56.4	32.7	93.0	↑	↑	39.5	120	95	107	517	517
58	90.5	16.0	79.8	55.7	31.7	92.5	↑	↑	39.0	118	94	106	512	512
57	90.0	14.5	79.5	55.0	30.7	92.0	↑	↑	38.6	117	92	104	507	507
56	89.4	13.0	79.2	54.4	29.7	91.0	↑	↑	38.1	115	91	103	502	502
55	88.8	11.5	78.8	53.7	28.7	90.5	↑	↑	37.7	114	90	101	497	497
54	88.2	10.0	78.5	53.0	27.7	90.0	↑	↑	37.2	112	89	100	492	492
53	87.7	8.5	78.2	52.4	26.7	89.5	↑	↑	36.8	111	87	NA	487	487
52	87.1	7.0	77.9	51.7	25.7	89.0	↑	↑	36.3	110	86		482	482
51	86.5	5.5	77.5	51.0	24.7	88.0	↑	↑	35.9	109	85		477	477
50	86.0	4.0	77.2	50.3	23.7	87.5	↑	↑	35.5	108	84		472	472
49	85.4	2.5	76.9	49.7	22.7	87.0	↑	↑	35.0	107	83		468	468

49	84.8	NA	76.6	49.0	21.7	86.5		63.5	34.6	106	82			
48	84.3		76.2	48.3	20.7	85.5		62.5	34.1	105	81			
47	83.7		75.9	47.7	19.7	85.0		61.5	33.7	104	80			
46	83.1		75.6	47.0	18.7	84.5		61.0	33.3	103	80			
45	82.6		75.3	46.3	17.7	84.0		60.0	32.9	102	79			
44	82.0		74.9	45.7	16.7	83.5		59.0	32.4	101	78			
43	81.4		74.6	45.0	15.7	82.5		58.0	32.0	100	77			
42	80.8		74.3	44.3	14.7	82.0		57.5	31.6	99	76			
41	80.3		74.0	43.7	13.6	81.5		56.5	31.2	98	75			
40	79.7		73.6	43.0	12.6	81.0		55.5	30.7	97	75			
39	79.1		73.3	42.3	11.6	80.0		54.5	30.3	96	74			
38	78.6		73.0	41.6	10.6	79.5		54.0	29.9	95	73			
37	78.0		72.7	41.0	9.6	79.0	NA	53.0	29.5	94	72			
36	77.4		72.3	40.3	8.6	78.5	100	52.0	29.1	93	72			
35	76.9		72.0	39.6	7.6	78.0	99.5	51.5	28.7	92	71			
34	76.3		71.7	39.0	6.6	77.0	99.0	50.5	28.2	91	70			
33	75.7		71.4	38.3	5.6	76.5	98.8	49.5	27.8	90	69			
32	75.2		71.0	37.6	4.6	76.0	98.5	48.5	27.4	89	69			
31	74.6		70.7	37.0	3.6	75.5	98.0	48.0	27.0	88	68			
30	74.0		70.4	36.3	2.6	75.0	97.8	47.0	26.6	87	67			
29	73.5		70.0	35.6	1.0	74.0	97.5	46.0	26.0	87	66			
28	73.0		69.3	34.5	NA	73.5	97.0	45.0	25.5	86	66			
27	72.5		69.5	34.0		73.0	96.5	44.5	25.0	85	65			
26	72.0		69.0	33.0		72.5	96.3	43.5	24.5	84	65			
25	71.0		68.8	32.5		72.0	96.0	42.5	24.3	83	64			
24	70.5		68.5	32.0		71.0	95.5	41.5	24.0	82	64			
23	70.0		68.0	31.0		70.5	95.3	41.0	23.5	82	63			
22	69.5		67.8	30.5		70.0	95.0	40.0	23.0	81	62			
21	69.0		67.5	29.5		69.5	94.5	39.0	22.5	81	62			
20	68.5		67.3	29.0		68.5	94.3	38.0	22.0	80	61			
19	68.0		67.0	28.5		68.0	94.0	37.5	21.5	79	61			
18	67.0		66.5	27.5		67.5	93.5	36.5	21.3	78	60			
17	66.5		66.3	27.0		67.0	93.0	35.5	21.0	78	60			
16	66.0		66.0	26.0		66.5	92.8	35.0	20.5	77	59			
15	65.5		65.5	25.5		65.5	92.5	34.0	20.0	76	59			
14	65.0		65.3	25.0		65.0	92.0	33.0	NA	75	59			
13	64.5		65.0	24.0		64.5	91.8	32.0		75	58			
12	64.0		64.5	23.5		64.0	91.5	31.5		74	58			
11	63.5		64.3	23.0		63.5	91.0	30.5		73	57			
10	63.0		64.0	22.0		62.5	90.5	29.5		72	57			
9	62.0		63.8	21.5		62.0	90.3	29.0		71	57			
8	61.5		63.5	20.5		61.5	90.0	28.0		71	56			
7	61.0		63.0	20.0		61.0	89.5	27.0		70	56			
6	60.5		62.8	19.5		60.5	89.3	26.0		69	55			
5	60.0		62.5	18.5		60.0	89.0	25.5		69	55			
4	59.5		62.0	18.0		59.0	88.5	24.5		69	55			
3	59.0		61.8	17.0		58.5	88.0	23.5		68	54			
2	58.0		61.5	16.5		58.0	87.8	23.0		68	54			
1	57.5		61.0	16.0		57.5	87.5	22.0		63	54			
0	57.0		60.5	15.0		57.0	87.0	21.0		67	53			

NOTE 2

high nickel alloys do not conform closely to these general tables. Neither do cold-worked metals of low B-scale hardness such as aluminum and the softer alloys. Special correlations are needed for more exact relationships in these cases. All values are consistent with ASTM E-1

